



NEW
PERSPECTIVES
ON SCANDINAVIAN
DESIGN

MUUTO

NEW PERSPECTIVES ON SCANDINAVIAN DESIGN

Muuto is rooted in the Scandinavian design tradition characterized by enduring aesthetics, functionality, craftsmanship and an honest expression.

By expanding this heritage with forward-looking materials, techniques and bold creative thinking, our ambition is to deliver new perspectives on Scandinavian design.

In fact our name, Muuto, comes from *muutos*, meaning new perspective in Finnish. We handpick leading contemporary designers who are strong interpreters of our philosophy and combine their talents with the passionate Muuto creative team.

You will know our design because it has muutos: objects made sublime through new perspectives, enjoyed across the world, representing the best of Scandinavian design today.



INDEX

- Customize Your Design** 4
- Inspiration** 6
- Product information** 59
 - Furniture 60
 - Lighting 77
 - Accessories 81
- A Sustainable Perspective** 86
- Links** 88

DESIGNS FOR MODERN HOMES

We want to create designs that make spaces feel intuitively right, be it through the inviting comfort of a sofa, the ambient glow of a pendant lamp or the subtle texture of a coat hook, bringing modern sentiments and forward-thinking functionalities into everyday life.

Working from the belief that design can affect our wellbeing, we strive to offer an extensive selection of designs for the evolving needs of the modern home, rooted in the values of Scandinavian design. Alongside this, we continuously develop the Muuto universe of colors and textures for our products to create and complement atmospheres in any aesthetic direction. This allows you to explore the endless possibilities of our collection to find the exact match for your home.





+ 100.000
options across
the muuto collection

Explore our configurator
on muuto.com

AN EXTENSIVE READY-TO-SHIP COLLECTION

With our extensive **Ready-To-Ship** collection, many of our designs are available for immediate shipping in a broad selection of colors and upholsteries, spanning across furniture, lighting and accessories.

CUSTOMIZE YOUR DESIGN

Customize your favorite design in our **Product Configurator** on [Muuto.com](https://muuto.com) by selecting from a large variety of textile and leather upholsteries in thousands of colors across our **Made-To-Order** Options.

Textile or leather? Full or front upholstery? Green or Grey? Legs in Black or Chrome? Making a choice among the nearly infinite customization possibilities can seem overwhelming. Explore our take through the **Made-To-Order Inspiration** Options that bring new perspectives to the individual product.

Get inspired on the following pages and learn more on the product information pages from p. 59 onwards and on [Muuto.com](https://muuto.com).

PRICES & WHERE TO BUY

All recommended retail prices in your currency are available on muuto.com

Fallen in love with a design? Find your nearest Muuto dealers in our **Store Locator** here muuto.com/store-locator or visit muuto.com/online-shops for an overview of our online dealers.





FLOW TROLLEY
by Normal Studio p. 82

COVER ARMCHAIR
by Tomas Bentzen p. 72

70/70 TABLE
by TAF Studio p. 79





RIME PENDANT LAMP
by TAF Studio p. 85

FIBER SIDE CHAIR
by Iskos-Berlin p. 68

WORKSHOP TABLE
by Cecilie Manz p. 79

KINK VASE
by Earnest Studio p. 91



RIME WALL LAMP



IN SITU MODULAR SOFA
by Anderssen & Voll p. 76

WORKSHOP COFFEE TABLE
by Cecilie Manz p. 81

PEBBLE RUG
by Margrethe Odgaard p. 92

POST FLOOR & WALL LAMP
by Earnest Studio p. 88

The Plank Coat Rack brings functional simplicity into daily life through its wooden composition and metal hooks. The design is made using FSC®-certified wood that comes from sustainably-managed forests



12



FLOW TROLLEY

FLOW TROLLEY
by Normal Studio p. 82

TIP FLOOR LAMP
by Jens Fager p. 88



LINEAR PENDANT LAMP
by Thomas Bentzen p. 87

FIBER ARMCHAIR
by Iskos-Berlin p. 68

70/70 TABLE
by TAF Studio p. 79



MINI STACKED STORAGE SYSTEM
by Julien De Smedt p. 82

RIME PENDANT LAMP
by TAF Studio p. 85

LINEAR WOOD BENCH
by Thomas Bentzen p. 79

RESTORE BASKET
by Mika Tolvanen p. 90

TIP WALL LAMP



15

TIP WALL LAMP
by Jens Fager p. 88

AIRY COFFEE TABLE
by Cecilie Manz p. 81

TWINE CUSHION
by Aiayu p. 93





AROUND COFFEE TABLE
by Thomas Bentzen p. 81

OUTLINE SOFA
by Anderssen & Voll p. 75

STRAND PENDANT LAMP
by Benjamin Hubert p. 85

FLOW TROLLEY
by Normal Studio p. 89



STACKED STORAGE SYSTEM
by Julien De Smedt p. 83

DOZE LOUNGE CHAIR
by Anderssen & Voll p. 78

DOZE OTTOMAN
by Anderssen & Voll p. 78

POST FLOOR LAMP
by Earnest Studio p. 88



BEAM TABLE LAMP

STORY PINBOARD

20



STORY PINBOARD
by Big-Game p. 90

LINEAR TABLE LAMP
by Thomas Bentzen p. 87



VISU CHAIR
by Mika Tolvanen p. 74

70/70 TABLE
by TAF Studio p. 79

KINK VASE
by Earnest Studio p. 91

GRAIN PENDANT LAMP
by Jens Fager p. 86

LINEAR STEEL SERIES

22



LINEAR STEEL ARMCHAIR
by Thomas Bentzen p. 80

LINEAR STEEL CAFÉ TABLE
by Thomas Bentzen p. 80



LINEAR STEEL TABLE & BENCH
by Thomas Bentzen p. 80

TUB JUG
by Atelier BLI19 p. 91



24

LINEAR STEEL TABLE
by Thomas Bentzen p. 80

LINEAR STEEL ARMCHAIR
by Thomas Bentzen p. 80





DOZE LOUNGE CHAIR
by Anderssen & Voll p. 78

DOZE OTTOMAN
by Anderssen & Voll p. 78

ARRANGE DESKTOP SERIES



27

ARRANGE DESKTOP SERIES
by Big-Game p. 90

TIP TABLE LAMP
by Jens Fager p. 87

WORKSHOP TABLE
by Cecilie Manz p. 79

The Post Wall Lamp brings an innovative character to modern lighting through its graphic expression, forward-thinking functionalities and refined finish

28





FIBER SIDE CHAIR
by Iskos-Berlin p. 69

70/70 TABLE
by TAF Studio p. 79

RIDGE VASE
by Studio Kaksiikko p. 91

STRAND PENDANT LAMP
by Benjamin Hubert p. 85



OUTLINE SOFA 3-SEATER
by Anderssen & Vøll p. 75

PEBBLE RUG
by Margrethe Odgaard p. 92

FIBER LOUNGE CHAIR
by Iskos-Berlin p. 71

LEAF FLOOR LAMP
by Broberg & Ridderstråle p. 88

LINEAR TABLE LAMP



31

LINEAR TABLE LAMP
by Thomas Bentzen p. 87

WORKSHOP CHAIR
by Cecilie Manz p. 71

WORKSHOP TABLE
by Cecilie Manz p. 79

ARRANGE DESKTOP SERIES
by Big-Game p. 90

OUTLINE DAYBED

32



OUTLINE DAYBED
by Anderssen & Voll p. 75

POST FLOOR LAMP
by Earnest Studio p. 88



LINEAR WOOD TABLE
by Thomas Bentzen p. 79

OSLO SIDE CHAIR
by Anderssen & Voll p. 73

STRAND PENDANT LAMP
by Benjamin Hubert p. 85

KINK VASE
by Earnest Studio p. 91





IN SITU MODULAR SOFA
by Anderssen & Vøll p. 76

WORKSHOP COFFEE TABLE
by Cecilie Manz p. 81

REFLECT SIDEBOARD
by Søren Rose Studio p. 84

RELATE SIDE TABLE
by Big-Game p. 81

FRAMED MIRROR

36



OUTLINE DAYBED
by Anderssen & Voll p. 75

FRAMED MIRROR
by Anderssen & Voll p. 89

ATTACH COAT HOOK
by Dimitri Bähler p. 89



FIBER ARMCHAIR
by Iskos-Berlin p. 69

WORKSHOP TABLE
by Cecilie Manz p. 79

STACKED STORAGE SYSTEM
by Julien De Smedtp. 83

RESTORE BASKET
by Mika Tolvanen p. 90



WORKSHOP COFFEE TABLE
by Cecilie Manz p. 81

PLY RUG
by Margrethe Odgaard p. 92

POST FLOOR LAMP
by Farnest Studio p. 88

**OUTLINE SOFA 3-SEATER
& STUDIO CHAIR**
by Anderssen & Voll p. 85



Designed with soft, playful shapes, the Strand Pendant Lamp is created in a sprayed material of tiny strands for a complex, intriguing structure, giving the light an almost cloud-like expression and comfortable glow



40

LAYER CUSHION



FIBER SIDE CHAIR
by Iskos-Berlin p. 68

LINEAR WOOD TABLE & BENCH
by Thomas Bentzen p. 79

UNFOLD PENDANT LAMP
by Form Us With Love p. 86

ENFOLD SIDEBOARD
by Thomas Bentzen p. 84



RESTORE BASKET SERIES



ECHO POUF
by Anderssen & Völl p. 78

POST FLOOR LAMP
by Earnest Studio p. 88

PEBBLE RUG
by Margrethe Odgaard p. 92



COVER SIDE CHAIR
by Thomas Bentzen p. 72

70/70 TABLE
by TAF Studio p. 79

PEBBLE RUG
by Margrethe Odgaard p. 92

KINK VASE
by Earnest Studio p. 91



STRAND PENDANT LAMP
by Benjamin Hubert p. 85

TUB JUG
by Atelier BLI19 p. 91

FIBER COUNTER STOOL
by Iskos-Berlin p. 70

46



DOTS COAT HOOKS

DOTS METAL
by Lars Tornøe p. 89

DOTS CERAMIC
by Lars Tornøe p. 89



IN SITU MODULAR SOFA
by Anderssen & Voll p. 76

HALVES SIDE TABLE
by MSDS Studio p. 81

STRAND PENDANT LAMP
by Benjamin Hubert p. 85

PLY RUG
by Margrethe Odgaard p. 92

RIDGE VASE

48



RIDGE VASE
by Studio Kaksikko p. 91

WORKSHOP CHAIR
by Cecilie Manz p. 71



FIBER ARMCHAIR
by Iskos-Berlin p. 68

RIME PENDANT LAMP
by TAF Studio s. 85

70/70 TABLE
by TAF Studio p. 79

PLY RUG
by Margrethe Odgaard p. 92



CONNECT MODULAR SOFA
by Anderssen & Voll p. 77

AROUND COFFEE TABLE
by Thomas Bentzen p. 81

PULL FLOOR LAMP
by Whatswhat p. 88

FIBER LOUNGE CHAIR
by Iskos-Berlin p. 71



51

KINK VASE



FIBER STOOL



WORKSHOP CHAIR
by Cecilie Manz p. 71

WORKSHOP TABLE
by Cecilie Manz p. 79

RIME PENDANT LAMP
by TAF Studio p. 85

COMPILE SHELVING SYSTEM
by Cecilie Manz p. 84



FOLDED SHELVES



REST SOFA
by Anderssen & Voll p. 77

PLY RUG
by Margrethe Odgaard p. 92

AIRY COFFEE TABLE
by Cecilie Manz p. 81

E27 PENDANT LAMP
by Mattias Ståhlbom p. 86



LOFT CHAIR
by Thomas Bentzen p. 73

AMBIT PENDANT LAMP
by TAF Studio p. 85

BASE TABLE
by Mika Tolvanen p. 79

E27 PENDANT LAMP
by Mattias Ståhlbom p. 86



RELATE SIDE TABLE

RELATE SIDE TABLE
by Big-Game p. 81

BEAM TABLE LAMP
by Tom Chung p. 87

PEBBLE RUG
by Margrethe Odgaard p. 92

58



AROUND COFFEE TABLE

AROUND COFFEE TABLE
by Thomas Bentzen p. 81

POST FLOOR LAMP
by Earnest Studio p. 88

KINK VASE
by Earnest Studio p. 91

FURNITURE
60 — 76

LIGHTING
77 — 80

ACCESSORIES
81 — 85



FURNITURE

FIBER ARMCHAIR WOOD BASE by Iskos-Berlin

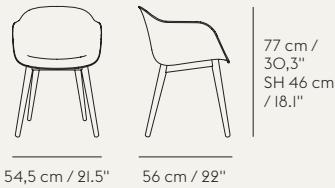

READY-TO-SHIP OPTIONS

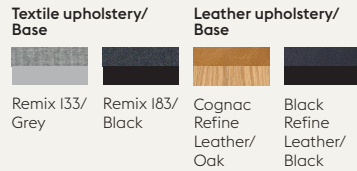
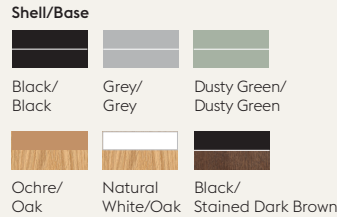

MADE-TO-ORDER INSPIRATION



MATERIAL

The shell consists of a PP composition with up to 25% wood fibers and colored polypropylene. Option of approved textile and leather upholstered seat. Base in solid oak and plywood with a water-based lacquer

MADE-TO-ORDER OPTIONS

Front upholstery and full upholstery versions with other textiles and leather available as made-to-order options

PRICE

From € 349 / £ 315 / DKK 2.495 / SEK 3.349 / NOK 3.349 / USD 419 / CAD 545

Please note that the Ready-To-Ship Options may be subject to regional stock. Consult your Muuto dealer or refer to price list for further information

FIBER SIDE CHAIR WOOD BASE by Iskos-Berlin

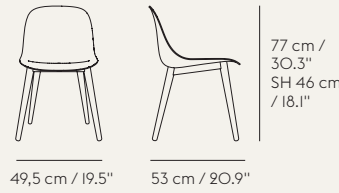

READY-TO-SHIP OPTIONS

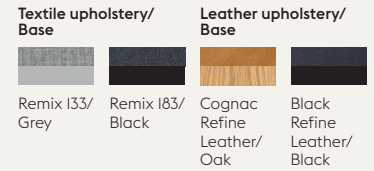
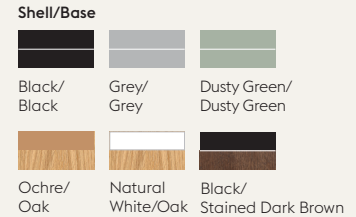

MADE-TO-ORDER INSPIRATION



MATERIAL

The shell consists of a PP composition with up to 25% wood fibers and colored polypropylene. Option of textile and leather upholstered seat. Base in solid oak and plywood with a water-based lacquer

MADE-TO-ORDER OPTIONS

Other textiles and leather upholsteries available as made-to-order options

PRICE

From € 305 / £ 275 / DKK 2.349 / SEK 3.195 / NOK 3.195 / USD 369 / CAD 479

Please note that the Ready-To-Ship Options may be subject to regional stock. Consult your Muuto dealer or refer to price list for further information

FIBER ARMCHAIR TUBE & SLED BASE by Iskos-Berlin

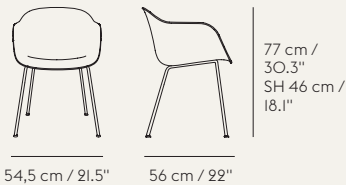

READY-TO-SHIP OPTIONS

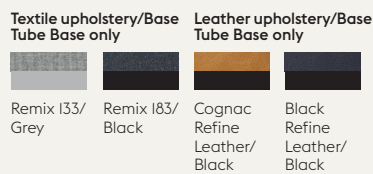
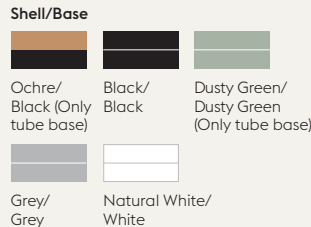

MADE-TO-ORDER INSPIRATION

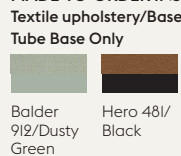

MATERIAL

The shell consists of a PP composition with up to 25% wood fibers and colored polypropylene. Option of textile and leather upholstered seat. Base in powder coated steel

MADE-TO-ORDER OPTIONS

Front upholstery and full upholstery versions with other approved textiles and leather available as made-to-order options. Base in powder coated steel or Chrome finish (Only tube base)

PRICE

From € 259 / £ 235 / DKK 1.849 / SEK 2.495 / NOK 2.495 / USD 315 / CAD 405

Please note that the Ready-To-Ship Options may be subject to regional stock. Consult your Muuto dealer or refer to price list for further information

FIBER SIDE CHAIR TUBE & SLED BASE by Iskos-Berlin



READY-TO-SHIP OPTIONS

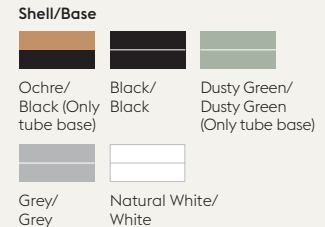

MADE-TO-ORDER INSPIRATION

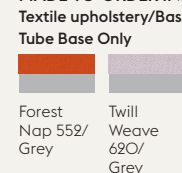

MATERIAL

The shell consists of a PP composition with up to 25% wood fibers and colored polypropylene. Option of textile and leather upholstered seat. Base in powder coated steel

MADE-TO-ORDER OPTIONS

Other approved textiles and leather upholsteries available as made-to-order options

PRICE

From € 235 / £ 215 / DKK 1.749 / SEK 2.349 / NOK 2.349 / USD 285 / CAD 375

Please note that the Ready-To-Ship Options may be subject to regional stock. Consult your Muuto dealer or refer to price list for further information

P. 8 Fiber Side Chair Tube Base Balder 912/Dusty Green

FIBER ARMCHAIR SWIVEL BASE & SWIVEL BASE W. CASTORS
by Iskos-Berlin

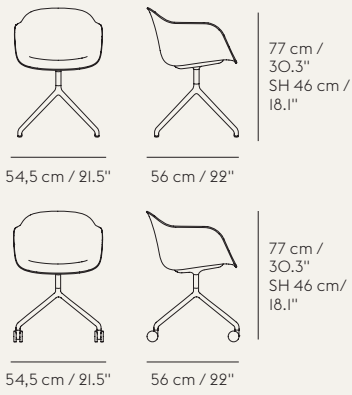

READY-TO-SHIP OPTIONS

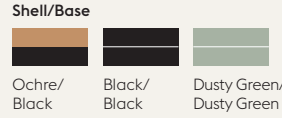

P. 37 Fiber Armchair Front Upholstery Swivel Base Balder 432/White

MADE-TO-ORDER INSPIRATION
Textile upholstery/base Swivel Base only

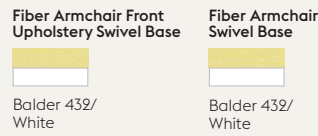

MATERIAL

The shell consists of a PP composition with up to 25% wood fibers and colored polypropylene. Option of textile and leather upholstered seat. Base in powder coated aluminum or polished aluminum

MADE-TO-ORDER OPTIONS

Front upholstery and full upholstery in other approved textiles or leather available made-to-order. Swivel Base w. Return, Swivel Base w. Castors and Swivel Base w. Castors and Gas Lift are made-to-order. Polished aluminum base available as made-to-order for EU versions w.o. Return and w. Return

PRICE
From € 379 / £ 345 / DKK 2.795 / SEK 3.795 / NOK 3.795 / USD 475 / CAD 599

Please note that the Ready-To-Ship Options may be subject to regional stock. Consult your Muuto dealer or refer to price list for further information

FIBER SIDE CHAIR SWIVEL BASE & SWIVEL BASE W. CASTORS
by Iskos-Berlin

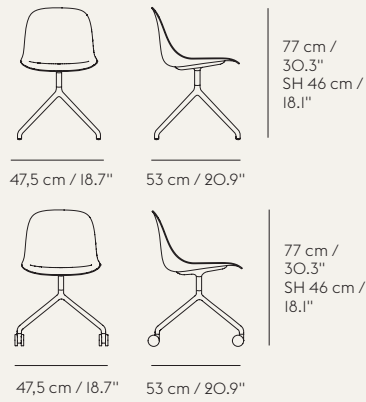

READY-TO-SHIP OPTIONS

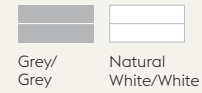
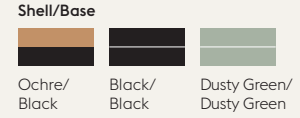

P. 29 Fiber Side Chair Swivel Base Twill Weave 780/Polished Aluminum

MADE-TO-ORDER INSPIRATION
Textile upholstery/base Swivel Base only



MATERIAL

The shell consists of a PP composition with up to 25% wood fibers and colored polypropylene. Option of textile and leather upholstered seat. Base in powder coated aluminum or polished aluminum

MADE-TO-ORDER OPTIONS

Full upholstery in other approved textiles or leather available made-to-order. Swivel Base w. Return, Swivel Base w. Castors and Swivel Base w. Castors and Gas Lift are made-to-order. Polished aluminum base available as made-to-order for EU versions w.o. Return and w. Return

PRICE
From € 319 / £ 289 / DKK 2.395 / SEK 3.249 / NOK 3.249 / USD 465 / CAD 479

Please note that the Ready-To-Ship Options may be subject to regional stock. Consult your Muuto dealer or refer to price list for further information

FIBER COUNTER & BAR STOOL W. BACK TUBE BASE
by Iskos-Berlin



READY-TO-SHIP OPTIONS



Leather upholstery/Base

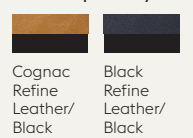

MATERIAL

The shell consists of a PP composition with up to 25% wood fibers and colored polypropylene. Option of textile and leather upholstered seat. Base in powder coated steel

MADE-TO-ORDER OPTIONS

Made-to-order textile and leather with base color option of Black, Grey, White, or Dusty Green

PRICE
From € 255 / £ 229 / DKK 1.949 / SEK 2.649 / NOK 2.649 / USD 315 / CAD 405

Please note that the Ready-To-Ship Options may be subject to regional stock. Consult your Muuto dealer or refer to price list for further information

FIBER COUNTER & BAR STOOL W. BACK WOOD BASE
by Iskos-Berlin



READY-TO-SHIP OPTIONS



Leather upholstery/Base

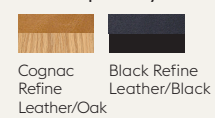

MADE-TO-ORDER INSPIRATION



MATERIAL

The shell consists of a PP composition with up to 25% wood fibers and colored polypropylene. Option of textile and leather upholstered seat. Base in solid oak and plywood

MADE-TO-ORDER OPTIONS

Made-to-order textile and leather with base color option of Black, Grey, Oak or Dusty Green

PRICE
From € 385 / £ 349 / DKK 2.795 / SEK 3.795 / NOK 3.795 / USD 465 / CAD 599

Please note that the Ready-To-Ship Options may be subject to regional stock. Consult your Muuto dealer or refer to price list for further information

FIBER COUNTER & BAR STOOL TUBE BASE

by Iskos-Berlin

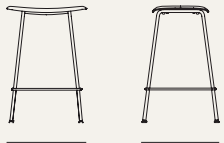

45 cm / 17.7"

44 cm / 17.3"

66 cm /
26"
SH 65 cm /
25.6"

READY-TO-SHIP OPTIONS

Shell/Base



Black/
Black

Grey/
Grey

Natural
White/White

Leather upholstery/Base

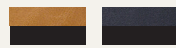

Cognac
Refine
Leather/
Black

Black
Refine
Leather/
Black

MATERIAL

The shell consists of a PP composition with up to 25% pine wood fibers and colored polypropylene. Option of textile and leather upholstered seat. Base in powder coated steel

MADE-TO-ORDER OPTIONS

Made-to-order textile and leather with base color option of Black, Grey, White, Dusty Green. Please consult your nearest Muuto dealer for further information

PRICE

From € 235 / £ 215 / DKK 1.749 / SEK 2.349 / NOK 2.349 / USD 285 / CAD 375

Please note that the Ready-To-Ship Options may be subject to regional stock. Consult your Muuto dealer or refer to price list for further information

FIBER COUNTER & BAR STOOL WOOD BASE

by Iskos-Berlin



45 cm / 17.7"

42,5 cm / 16.7"

66 cm /
26"
SH 65 cm /
25.6"

READY-TO-SHIP OPTIONS

Shell/Base

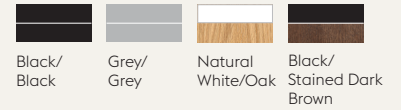

Black/
Black

Grey/
Grey

Natural
White/Oak

Black/
Stained Dark
Brown

Leather upholstery/Base

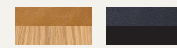

Cognac
Refine
Leather/
Oak

Black
Refine
Leather/
Black

MADE-TO-ORDER INSPIRATION

Shell/Base



Dusty Green/
Stained Dark Brown

MATERIAL

The shell consists of a PP composition with up to 25% wood fibers and colored polypropylene. Option of textile and leather upholstered seat. Base in solid oak and plywood with a water-based lacquer

MADE-TO-ORDER OPTIONS

Made-to-order textile and leather with base color option of black, grey, oak or dusty green. Please consult your nearest Muuto dealer for further information

PRICE

From € 369 / £ 335 / DKK 2.695 / SEK 3.649 / NOK 3.649 / USD 425 / CAD 549

Please note that the Ready-To-Ship Options may be subject to regional stock. Consult your Muuto dealer or refer to price list for further information

FIBER STOOL TUBE BASE

by Iskos-Berlin



45 cm / 17.7"

38,8 cm / 15.3"

46 cm /
18.1"
SH 45 cm /
17.7"

READY-TO-SHIP OPTIONS

Shell/Base



Black/
Black

Natural
White/
White

MATERIAL

The shell consists of a PP composition with up to 25% wood fibers and colored polypropylene. Option of textile and leather upholstered seat. Base in powder coated steel

MADE-TO-ORDER OPTIONS

Ochre/Black, Grey/Grey and Dusty Green/ Dusty Green are available as made-to-order. Other approved textile upholstered versions available as made-to-order options

PRICE

From € 179 / £ 165 / DKK 1.349 / SEK 1.849 / NOK 1.849 / USD 219 / CAD 285

Please note that the Ready-To-Ship Options may be subject to regional stock. Consult your Muuto dealer or refer to price list for further information

FIBER STOOL WOOD BASE

by Iskos-Berlin



45 cm / 17.7"

35,5 cm / 14"

46 cm /
18.1"
SH 45 cm /
17.7"

READY-TO-SHIP OPTIONS

Shell/Base



Natural
White/Oak

Black/
Black

MADE-TO-ORDER INSPIRATION

Shell/Base



Dusty Green/
Stained Dark Brown

MATERIAL

The shell consists of a PP composition with up to 25% wood fibers and colored polypropylene. Option of textile and leather upholstered seat. Base in solid oak and plywood with a water-based lacquer

MADE-TO-ORDER OPTIONS

Ochre/Oak, Grey/Grey and Dusty Green/ Dusty Green are available as made-to-order. Other approved textile upholstered versions available as made-to-order options

PRICE

From € 275 / £ 249 / DKK 2.049 / SEK 2.795 / NOK 2.795 / USD 335 / CAD 439

Please note that the Ready-To-Ship Options may be subject to regional stock. Consult your Muuto dealer or refer to price list for further information

FIBER LOUNGE CHAIR TUBE BASE
by Iskos-Berlin

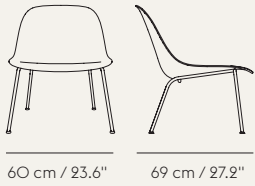

74,4 cm /
29,3"
SH 38 cm
/ 15"

READY-TO-SHIP OPTIONS

Shell/Base



Dusty Green/
Dusty Green

Textile upholstery/Base

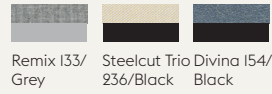

Leather upholstery/Base



Cognac Refine
Leather/Black

P. 30 Fiber Lounge Chair Tube Base Divina I54/Black

MATERIAL

The shell consists of a PP composition with up to 25% wood fibers and colored polypropylene. Option of textile and leather upholstered seat. Base in powder coated steel

MADE-TO-ORDER OPTIONS

Other approved textiles or leather upholsteries available as made-to-order

PRICE

From € 409 / £ 369 / DKK 3.095 / SEK 4.195 / NOK 4.195 / USD 499 / CAD 649

Please note that the Ready-To-Ship Options may be subject to regional stock. Consult your Muuto dealer or refer to price list for further information

60 cm / 23.6"
69 cm / 27.2"

FIBER LOUNGE CHAIR WOOD BASE
by Iskos-Berlin

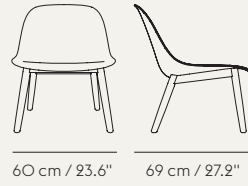

74,4 cm /
29,3"
SH 38 cm
/ 15"

READY-TO-SHIP OPTIONS

Shell/Base



Dusty Green/
Dusty Green

Textile upholstery/Base

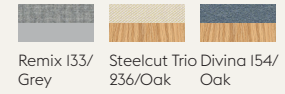

Leather upholstery/Base



Cognac Refine
Leather/Oak

MADE-TO-ORDER INSPIRATION

Shell/Base



Dusty Green/
Stained Dark Brown

MATERIAL

The shell consists of a PP composition with up to 25% wood fibers and colored polypropylene. Option of textile and leather upholstered seat. Base in solid oak and plywood

MADE-TO-ORDER OPTIONS

Other approved textiles or leather upholsteries available as made-to-order

PRICE

From € 559 / £ 505 / DKK 4.095 / SEK 5.549 / NOK 5.549 / USD 685 / CAD 889

Please note that the Ready-To-Ship Options may be subject to regional stock. Consult your Muuto dealer or refer to price list for further information

60 cm / 23.6"
69 cm / 27.2"

FIBER CHAIR SEAT PAD
by Iskos-Berlin



44,8 cm /
17,6"

11 mm /
0,43"

52,5 cm /
20,7"



37 cm /
14,6"

11 mm /
0,43"

43 cm /
16,9"

READY-TO-SHIP OPTIONS

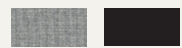

Remix I33 Black Easy
Leather

MATERIAL

Upholstered foam with black, anti-slip backing. Kvadrat textile or premium leather from European suppliers

PRICE

Fiber Armchair & Side Chair Seat Pad from from € 59 / £ 59 / DKK 395 / SEK 535 / NOK 499 / USD 75 / CAD 99

Fiber Lounge Chair Seat Pad from € 69 / £ 79 / DKK 495 / SEK 665 / NOK 625 / USD 89 / CAD 115

Please note that the Ready-To-Ship Options may be subject to regional stock. Consult your Muuto dealer or refer to price list for further information

WORKSHOP CHAIR
by Cecilie Manz

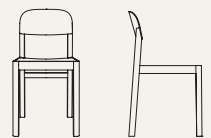

79 cm / 31"
SH 45 cm /
17,75"

46 cm / 18"

READY-TO-SHIP OPTIONS



Black Oak Oregon Pine

MATERIAL

Oak & Black version: Seat and back in oak veneer while frame and legs are made in solid oak, all parts in a water-based lacquer.

Oregon Pine version: Frame and legs in solid Oregon pine while seat and back are made in Oregon pine veneer, all parts in a water-based lacquer

PRICE

€ 375 / £ 339 / DKK 2.695 / SEK 3.649 / NOK 3.649 / USD 415 / CAD 535

COVER ARMCHAIR

by Thomas Bentzen



READY-TO-SHIP OPTIONS



Upholstered seat/Leather

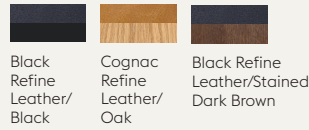

Upholstered seat/Textile



PRICE

From € 429 / £ 385 / DKK 3.195 / SEK 4.295 / NOK 4.295 / USD 499 / CAD 649

MATERIAL

Oak version: Form pressed oak veneer shell. Frame is made from solid oak. All parts with water-based lacquer. Colored version: Seat and backrest in form pressed oak veneer. Base and legs from solid oak. All parts with water-based lacquer. Textiles from Kvadrat and leather from premium leather suppliers.

MADE-TO-ORDER OPTIONS

Other approved textiles or leather upholstery available as made-to-order

Please note that the Ready-To-Ship Options may be subject to regional stock. Consult your Muuto dealer or refer to price list for further information

COVER LOUNGE CHAIR

by Thomas Bentzen

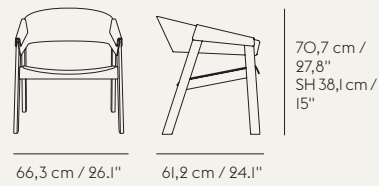

READY-TO-SHIP OPTIONS



Upholstered seat/Leather

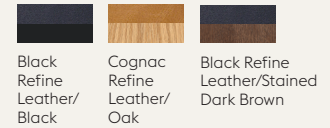

Upholstered seat/Textile



Cover Lounge Chair p. 37 in Cognac Refine Leather/Oak

PRICE

From € 795 / £ 715 / DKK 5.995 / SEK 8.049 / NOK 8.049 / USD 995 / CAD 1,295

MATERIAL

Oak version: Seat, back and armrests in form-pressed oak veneer. Frame and legs in solid oak. All parts in PU lacquer. Colored versions: Seat, back and armrests in ash veneer. Frame and legs in solid oak. All parts in PU lacquer.

MADE-TO-ORDER OPTIONS

Other approved textiles or leather upholstery available as made-to-order

Please note that the Ready-To-Ship Options may be subject to regional stock. Consult your Muuto dealer or refer to price list for further information

COVER SIDE CHAIR

by Thomas Bentzen

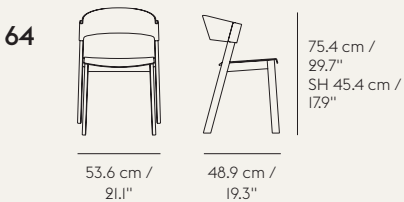

READY-TO-SHIP OPTIONS

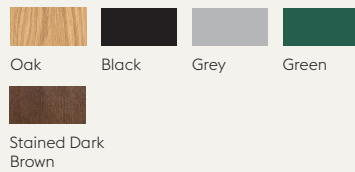

MADE-TO-ORDER INSPIRATION Upholstered seat/Leather



Upholstered seat/Textile



P. 44 Cover Side Chair Refine Leather Cognac/Oak

MATERIAL

Oak version: Form pressed oak veneer shell. Frame is made from solid oak. All parts with water-based lacquer. Stacking pad in felt. Colored version: Seat and backrest in form pressed oak veneer. Base and legs from solid oak. All parts with water-based lacquer. Stacking pad in felt. Textiles from Kvadrat and leather from premium leather suppliers.

MADE-TO-ORDER OPTIONS

Other approved textiles or leather upholstery available as made-to-order

PRICE

From € 395 / £ 355 / DKK 2.995 / SEK 4.049 / NOK 4.049 / USD 495 / CAD 645

Please note that the Ready-To-Ship Options may be subject to regional stock. Consult your Muuto dealer or refer to price list for further information

NERD CHAIR

by David Geckeler

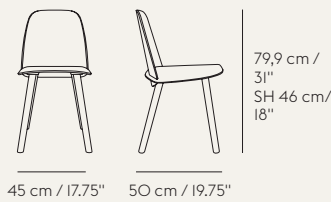

READY-TO-SHIP OPTIONS

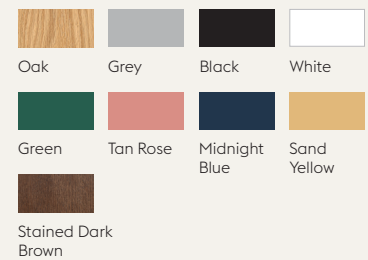

MATERIAL

Seat and back in form-pressed veneer. Legs in solid wood. All parts in water-based lacquer

PRICE

€ 395 / £ 355 / DKK 2.695 / SEK 3.649 / NOK 3.649 / USD 499 / CAD 615

NERD COUNTER & BAR STOOL

by David Geckeler



READY-TO-SHIP OPTIONS

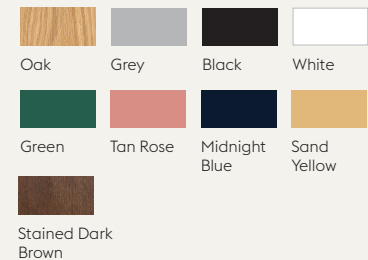

MATERIAL

Seat and back in form-pressed veneer. Legs in solid wood. All parts in water-based lacquer

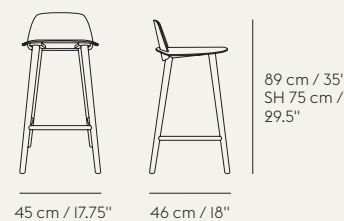

MADE-TO-ORDER OPTIONS

Bar Stool in 75 cm, Counter stool in 65 cm seat height. Please consult your Muuto dealer for further information

PRICE

€ 449 / £ 405 / DKK 3.395 / SEK 4.595 / NOK 4.595 / USD 549 / CAD 715

OSLO SIDE CHAIR
by Anderssen & Voll

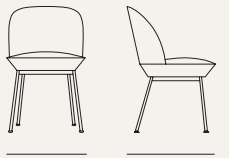

80,5 cm / 31,7"
SH 45 cm / 17,75"

51 cm / 20,08" 56 cm / 22,05"

P. 33 Oslo Side Chair Still 94I/Chrome

READY-TO-SHIP OPTIONS

Textile upholstery/Base

Ocean 32/ Chrome Ocean 60I/ Anthracite Black Still 16I/ Anthracite Black Twill Weave 99O/ Chrome

MADE-TO-ORDER INSPIRATION

Textile upholstery/Base

Ocean 52/ Anthracite Black Ocean 2I/ Anthracite Black Ocean 8O/ Anthracite Black Ocean 5O/ Chrome
Ocean 3/ Anthracite Black Steelcut 24O/ Chrome Steelcut 775/ Anthracite Black Still 94I/ Chrome
Twill Weave 53O/ Chrome Twill Weave 53O/ Anthracite Black

MATERIAL

Steel frame, moulded foam & textile from Kvadrat or Rohleder. Made-to-order textiles with option of anthracite black or chrome legs

MADE-TO-ORDER OPTIONS

Other approved textile upholsteries available as made-to-order

PRICE

From € 695 / £ 649 / DKK 4.995 / SEK 6.495 / NOK 6.749 / USD 869 / CAD 1,149

Please note that the Ready-To-Ship Options may be subject to regional stock. Consult your Muuto dealer or refer to price list for further information

OSLO BAR & COUNTER STOOL
by Anderssen & Voll

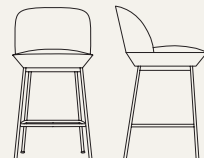

93,5 cm / 36,8"
SH 44 cm / 17,32"

51 cm/20.1" 55 cm / 21.7"

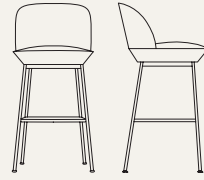

103,5 cm / 40,8"
SH 75 cm / 29,5"

51 cm/20.1" 55 cm / 21.7"

READY-TO-SHIP OPTIONS

Textile upholstery/Base

Ocean 32/ Chrome Still 16I/ Anthracite Black

MADE-TO-ORDER INSPIRATION

Textile upholstery/Base

Ocean 3/ Anthracite Black Ocean 2I/ Anthracite Black Ocean 5O/ Chrome Ocean 52/ Anthracite Black
Ocean 8O/ Anthracite Black Ocean 60I/ Anthracite Black Steelcut 24O/ Chrome Steelcut 775/ Anthracite Black
Still 94I/ Chrome Twill Weave 99O/ Chrome Twill Weave 53O/ Anthracite Black

MATERIAL

Steel frame, moulded foam and textile from Kvadrat and Rohleder. Made-to-order textiles with option of anthracite black or chrome legs.

MADE-TO-ORDER OPTIONS

Other approved textile upholsteries available as made-to-order

PRICE

From € 749 / £ 715 / DKK 5.495 / SEK 7.395 / NOK 7.395 / USD 935 / CAD 1,249

LOFT CHAIR
by Thomas Bentzen

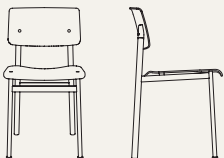

78,5 cm / 31"
SH 46 cm / 18"

42,5 cm / 31" 48 cm / 19"

READY-TO-SHIP OPTIONS

Shell/Base

Oak/ Black Oak/ White Oak/ Dusty Rose Oak/ Dusty Green
Black/ Black Black/ Stained Dark Brown

MADE-TO-ORDER INSPIRATION

Shell/Base/Textile

Black/ Black/ Steelcut 190 Oak/ White/ Steelcut Trio 205 Oak/ Dusty Green/ Rose/ Steelcut Trio 966 Oak/ Dusty Rose/ Steelcut Trio 515
Oak/ Black/ Steelcut 190

MATERIAL

Back and seat in oak veneer. Frame in powder coated steel

MADE-TO-ORDER OPTIONS

Variants with upholstered seat are available as made-to-order in a large range of approved textiles and colors

PRICE

From € 319 / £ 289 / DKK 2.395 / SEK 3.249 / NOK 3.249 / USD 375 / CAD 485

Please note that the Ready-To-Ship Options may be subject to regional stock. Consult your Muuto dealer or refer to price list for further information

LOFT COUNTER & BAR STOOL
by Thomas Bentzen

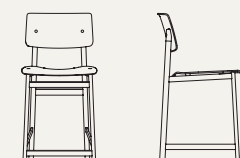

98,5 cm / 38,75"
SH 65 cm / 25,5"

42,5 cm / 16,75" 49 cm / 19,25"

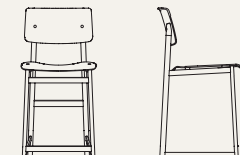

108,5 cm / 42,75"
SH 75 cm / 29,5"

43,5 cm / 17,25" 49 cm / 19,25"

READY-TO-SHIP OPTIONS

Shell/Base

Oak/ Black Oak/ White Oak/ Dusty Rose Oak/ Dusty Green
Black/ Black Black/ Stained Dark Brown

MADE-TO-ORDER INSPIRATION

Shell/Base/Textile

Black/ Black/ Steelcut 190 Oak/ White/ Steelcut Trio 205 Oak/ Dusty Green/ Rose/ Steelcut Trio 966 Oak/ Dusty Rose/ Steelcut Trio 515
Oak/ Black/ Steelcut 190

MATERIAL

Back and seat in oak veneer. Frame in powder coated steel

MADE-TO-ORDER OPTIONS

Variants with upholstered seat are available as made-to-order in a large range of approved textiles and colors

PRICE

From € 419 / £ 379 / DKK 3.095 / SEK 4.195 / NOK 4.195 / USD 499 / CAD 649

Please note that the Ready-To-Ship Options may be subject to regional stock. Consult your Muuto dealer or refer to price list for further information

VISU CHAIR WOOD BASE
by Mika Tolvanen



78,5 cm / 31"
SH 46 cm / 18"

46 cm / 18" 51 cm / 20"

READY-TO-SHIP OPTIONS

Shell/Base

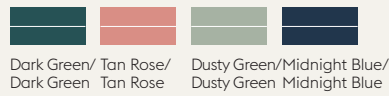
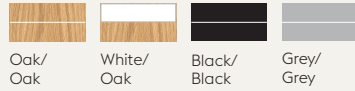

MATERIAL

Form-pressed ash or oak veneer shell and base, both in water-based lacquer with the option of textile or leather upholstery

MADE-TO-ORDER OPTIONS

Other approved textiles available as made-to-order options. Shell available with textile or leather upholstery

PRICE

From € 299 / £ 269 / DKK 2.195 / SEK 2.949 / NOK 2.949 / USD 375 / CAD 485

Please note that the Ready-To-Ship Options may be subject to regional stock. Consult your Muuto dealer or refer to price list for further information

VISU CHAIR SLED BASE
by Mika Tolvanen

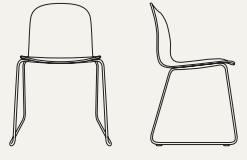

78 cm / 30.75"
SH 46 cm / 18"

53,5 cm / 21" 50 cm / 19.5"

READY-TO-SHIP OPTIONS

Shell/Base



MATERIAL

Form-pressed ash or oak veneer shell and base, both in water-based lacquer with the option of textile or leather upholstery. wood, textile or leather upholstered seat Powder coated steel base. Stackable

MADE-TO-ORDER OPTIONS

Approved textiles and leather available as made-to-order

PRICE

From € 259 / £ 235 / DKK 1.849 / SEK 2.495 / NOK 2.495 / USD 315 / CAD 405

Please note that the Ready-To-Ship Options may be subject to regional stock. Consult your Muuto dealer or refer to price list for further information

VISU CHAIR TUBE BASE
by Mika Tolvanen



78 cm / 30.75"
SH 46 cm / 18"

53,5 cm / 21" 50 cm / 19.75"

READY-TO-SHIP OPTIONS

Shell/Base

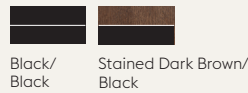

MATERIAL

Form-pressed ash or oak veneer shell in water-based lacquer with the option of textile or leather upholstery. Base in powder coated steel. Up to 15 non-upholstered chairs can be stacked together

PRICE

€ 259 / £ 235 / DKK 1.849 / SEK 2.495 / NOK 2.495 / USD 315 / CAD 405

Please note that the Ready-To-Ship Options may be subject to regional stock. Consult your Muuto dealer or refer to price list for further information

VISU WIDE CHAIR WOOD BASE & SWIVEL BASE
by Mika Tolvanen



78,5 cm / 31"
SH 45 cm / 17.75"

50 cm / 19.75" 55 cm / 21.75"

MATERIAL

Wood Base: Shell in ash or oak veneer shell with form-pressed veneer base, both in water-based lacquer
Swivel Base: Shell in ash or oak veneer with water-based lacquer. Swivel Base in powder coated aluminum

MADE-TO-ORDER OPTIONS

The Visu Wide Chair is a made-to-order design. Other approved textile or leather upholsteries are also available as made-to-order

PRICE

From € 379 / £ 345 / DKK 2.749 / SEK 3.695 / NOK 3.695 / USD 465 / CAD 599

Please note that the Ready-To-Ship Options may be subject to regional stock. Consult your Muuto dealer or refer to price list for further information

VISU COUNTER & BAR STOOL
by Mika Tolvanen



78,5 cm / 31"
SH 65 cm / 25.5"

42,7 cm / 16.75" 42,3 cm / 16.75"

READY-TO-SHIP OPTIONS

Shell/Base

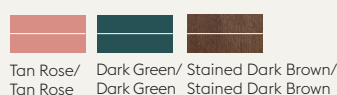
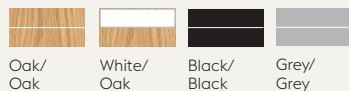

MATERIAL

Shell in form-pressed ash or oak veneer and base in solid wood—both in a water-based lacquer—alongside a powder coated or stainless steel footrest. Option of textile or leather upholstery.

MADE-TO-ORDER OPTIONS

Variants with upholstered seat are available as made-to-order in a large range of approved textiles and colors

PRICE

From € 449 / £ 405 / DKK 3.395 / SEK 4.595 / NOK 4.595 / USD 549 / CAD 715

Please note that the Ready-To-Ship Options may be subject to regional stock. Consult your Muuto dealer or refer to price list for further information

VISU LOUNGE CHAIR
by Mika Tolvanen



69 cm / 27.25"
SH 40 cm / 15.75"

60 cm / 23.5" 51 cm / 20"

READY-TO-SHIP OPTIONS

Shell/Base



Textile upholstery/Base



MATERIAL

Shell in ash or oak veneer with form-pressed veneer base, both in water-based lacquer

MADE-TO-ORDER OPTIONS

Other approved textiles available as made-to-order options

PRICE

€ 439 / £ 395 / DKK 3.295 / SEK 4.449 / NOK 4.449 / USD 535 / CAD 695

Please note that the Ready-To-Ship Options may be subject to regional stock. Consult your Muuto dealer or refer to price list for further information

OUTLINE SOFA SERIES
by Anderssen & Voll

3 1/2-Seater

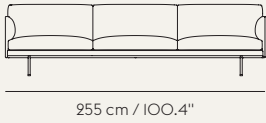

255 cm / 100.4"

Corner Sofa

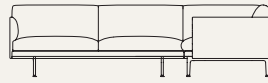

255 cm / 100.4"

71 cm / 28"
SH 40 cm / 15.75"

3-Seater



220 cm / 86.6"

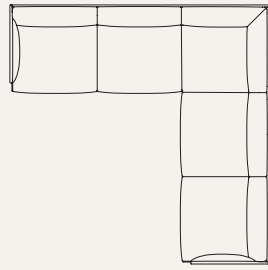

255 cm / 100.4"

2-Seater



170 cm / 66.9"



71 cm / 28"
SH 40 cm / 15.75"

86 cm / 33.9"

Chaise Longue

263 cm / 103.5"

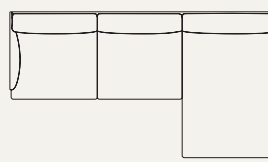

142 cm / 55.9"

95 cm / 37.4"

Chair

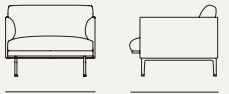

71 cm / 28"
SH 40 cm / 15.75"

88 cm / 34.6"

86 cm / 33.9"

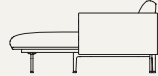

71 cm / 28"
SH 40 cm / 15.75"

Pouf

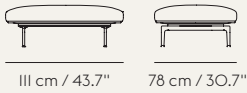

40 cm / 15.75"

111 cm / 43.7"

78 cm / 30.7"

Daybed

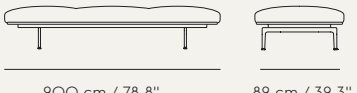

200 cm / 78.8"



40 cm / 15.75"

82 cm / 32.3"

Daybed Cushion



30 cm / 11.8"

12 cm / 4.7"

70 cm / 27.6"

Studio Sofa 220 cm / 86.6"

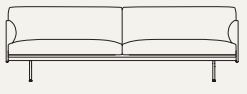

220 cm / 86.6"



71 cm / 28"
SH 40 cm / 15.75"

76 cm / 29.9"

Studio Sofa 170 cm / 66.9"



W 170 cm / 66.9"



71 cm / 28"
SH 40 cm / 15.75"

76 cm / 29.9"

Studio Sofa 140 cm / 55"



140 cm / 55"



71 cm / 28"
SH 40 cm / 15.75"

76 cm / 30"

Studio Chair

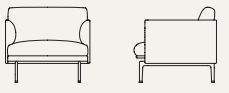

78 cm / 30.75"



71 cm / 28"
SH 40 cm / 15.75"

76 cm / 30"

PRICE

2-Seater textile from € 2,695 / £ 2,849 / DKK 19,995 / SEK 26,995 / NOK 26,995 / USD 3,395 / CAD 4,395

2-Seater leather from € 4,795 / £ 4,695 / DKK 35,995 / SEK 48,495 / NOK 48,495 / USD 5,995 / CAD 7,795

3-Seater textile from € 2,995 / £ 3,049 / DKK 21,995 / SEK 29,995 / NOK 29,995 / USD 3,749 / CAD 4,895

3-Seater leather from € 5,495 / £ 5,195 / DKK 39,995 / SEK 53,995 / NOK 53,995 / USD 6,849 / CAD 8,949

3 1/2-Seater textile from € 3,395 / £ 3,195 / DKK 24,995 / SEK 33,995 / NOK 33,995 / USD 4,249 / CAD 5,549

3 1/2-Seater leather from € 6,149 / £ 5,849 / DKK 43,995 / SEK 59,495 / NOK 59,495 / USD 7,695 / CAD 9,995

Corner Sofa textile from € 5,595 / £ 5,295 / DKK 39,995 / SEK 53,995 / NOK 53,995 / USD 6,995 / CAD 9,095

Corner Sofa leather from € 9,495 / £ 9,895 / DKK 69,995 / SEK 93,995 / NOK 93,995 / USD 11,995 / CAD 15,495

Chaise Longue textile from € 4,395 / £ 4,249 / DKK 31,995 / SEK 42,995 / NOK 42,995 / USD 5,495 / CAD 7,149

Chaise Longue leather from € 6,995 / £ 7,195 / DKK 49,995 / SEK 67,495 / NOK 67,495 / USD 8,749 / CAD 11,495

Pouf textile from € 995 / £ 1,049 / DKK 6,995 / SEK 9,395 / NOK 9,395 / USD 1,249 / CAD 1,649

Pouf leather from € 1,649 / £ 1,695 / DKK 12,495 / SEK 16,995 / NOK 16,995 / USD 2,095 / CAD 2,695

Daybed textile from € 1,995 / £ 2,049 / DKK 14,995 / SEK 20,495 / NOK 20,495 / USD 2,495 / CAD 3,249

Daybed leather from € 3,295 / £ 3,149 / DKK 24,995 / SEK 33,995 / NOK 33,995 / USD 4,149 / CAD 5,349

Daybed Cushion textile from € 269 / £ 269 / DKK 1,995 / SEK 2,695 / NOK 2,695 / USD 335 / CAD 439

Daybed Cushion leather from € 399 / £ 349 / DKK 2,995 / SEK 4,049 / NOK 4,049 / USD 499 / CAD 649

Chair textile from € 1,849 / £ 1,795 / DKK 13,495 / SEK 18,495 / NOK 18,495 / USD 2,349 / CAD 2,995

Chair leather from € 2,995 / £ 3,149 / DKK 22,495 / SEK 30,495 / NOK 30,495 / USD 3,749 / CAD 4,895

Studio Chair textile from € 1,649 / £ 1,595 / DKK 11,495 / SEK 15,495 / NOK 15,495 / USD 2,095 / CAD 2,695

Studio Chair leather from € 2,749 / £ 2,849 / DKK 19,995 / SEK 26,995 / NOK 26,995 / USD 3,449 / CAD 4,495

Studio Sofa 140 textile from € 2,349 / £ 2,249 / DKK 17,495 / SEK 23,495 / NOK 23,495 / USD 2,949 / CAD 3,849

Studio Sofa 140 leather from € 4,095 / £ 4,095 / DKK 30,995 / SEK 41,995 / NOK 41,995 / USD 5,149 / CAD 6,649

Studio Sofa 170 textile from € 2,495 / £ 2,449 / DKK 17,995 / SEK 24,495 / NOK 24,495 / USD 3,149 / CAD 4,049

READY-TO-SHIP OPTIONS

Textile upholstery/ Base



Leather upholstery/ Base



MADE-TO-ORDER INSPIRATION

Textile upholstery/Base

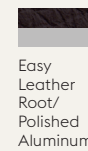
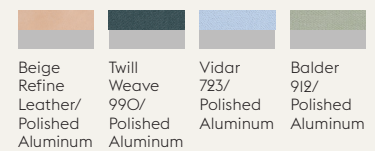

P. 16 Outline Sofa 3-Seater Vidar 723/Polished Aluminum

P. 30 Outline Sofa 3,5-Seater Refine Leather Stone/Black

P. 32 Outline Daybed Refine Leather Cognac/Black

P. 36 Outline Daybed Vidar 554/Polished Aluminum

P. 38 Outline Sofa 3-Seater Refine Leather Beige/Polished Aluminum

P. 38 Outline Studio Chair Twill Weave 990/Polished Aluminum

MATERIAL

Powder coated or polished aluminum base. Wood and steel construction. Cold foam filling. All textiles from Kvadrat or Arve

MADE-TO-ORDER OPTIONS

The Outline Corner, 3 1/2-Seater, Pouf, Chaise Longue and Studio versions are available as made-to-order. Chaise Longue available for left or right side. Other approved textiles and leather upholsteries are available as made-to-order. Polished Aluminum base is available for made-to-order versions

Please note that the Ready-To-Ship Options may be subject to regional stock. Consult your Muuto dealer or refer to price list for further information

Studio Sofa 170 leather from € 4,495 / £ 4,149 / DKK 33,995 / SEK 45,995 / NOK 45,995 / USD 5,649 / CAD 7,295

Studio Sofa 220 textile from € 2,695 / £ 2,649 / DKK 19,995 / SEK 26,995 / NOK 26,995 / USD 3,395 / CAD 4,395

Studio Sofa 220 leather from € 5,195 / £ 4,849 / DKK 38,995 / SEK 52,495 / NOK 52,495 / USD 6,495 / CAD 8,449

Leather prices refer to Muuto Refine Leather

IN SITU MODULAR SOFA

by Anderssen & Voll

Seating modules

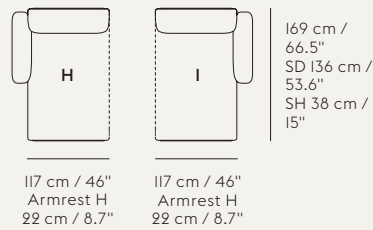
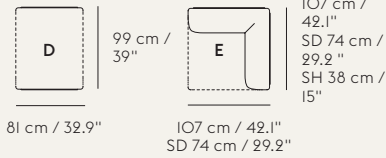
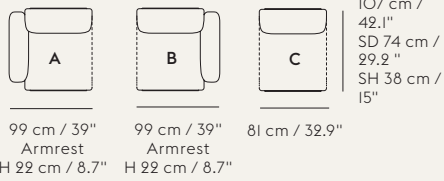

Cushions

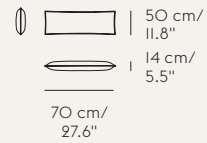
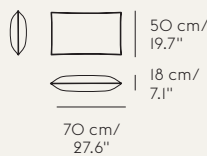

PRICE

2-Seater Config. from € 2.648 / £ 2,695 / DKK 19.490 / SEK 26.495 / NOK 26.495 / USD 3,349 / CAD 4,295

3-Seater Config. from € 3.318 / £ 3,349 / DKK 24.285 / SEK 32.995 / NOK 32.995 / USD 4,149 / CAD 5,395

4-Seater Config. from € 4.389 / £ 4,495 / DKK 32.281 / SEK 43.495 / NOK 43.495 / USD 5,495 / CAD 7,149

Corner Config. from € 5.860 / £ 5,949 / DKK 43.277 / SEK 58.495 / NOK 58.495 / USD 7,349 / CAD 9,495

Modules from € 595 / £ 585 / DKK 4.295 / SEK 5.795 / NOK 5.795 / USD 745 / CAD 965

Frame Section from € 75 / £ 69 / DKK 500 / SEK 675 / NOK 675 / USD 95 / CAD 125

Cushion 70 x 30 from € 95 / £ 109 / DKK 695 / SEK 935 / NOK 935 / USD 119 / CAD 155

Cushion 70 x 50 from € 129 / £ 135 / DKK 995 / SEK 1.349 / NOK 1.349 / USD 165 / CAD 209

P. IO In Situ Modular Sofa Corner Configuration 2 Vidar 554

P. 34 In Situ Modular Sofa Corner Configuration 9 Clay I2

P. 47 In Situ Modular Sofa 3-Seater Configuration 1 Fiord 451

Please note that the Ready-To-Ship Options may be subject to regional stock.

READY-TO-SHIP OPTIONS

Textile Upholstery/Base



MADE-TO-ORDER INSPIRATION

Textile Upholstery/Base



MATERIAL

Frame in powder coated steel. Modules in a wood construction with foam and wadding. Upholstered in textile from Kvadrat or Rohleder. The inner of the In Situ Cushion features a foam core with a pillowcase around that is filled with fiberballs. Outer in textile upholstery.

CONFIGURATIONS

Choose from any of the 30 predefined configurations or create your own, using the 9 different seating modules and 2 loose cushions. Please note that the In Situ Cushions are not part of any configuration or seating module and must be added separately to your order. We recommend to consult your Muuto dealer or refer to price list for further information and How-To-Order Guide

MADE-TO-ORDER OPTIONS

All In Situ modules and cushions can be upholstered in all colors from Kvadrat's Fiord, Vidar, Hallingdal, Divina, Divina MD & Divina Melange textile series, selected colors from Kvadrat's Clay (OO1, OO3, OO6, OO7, OO9, O10, O12, O13, O14, O15, O17) and selected colors from Rohleder's Ocean (3, 21, 32, 50, 52, 80, 601) textile series.

Customize Your Muuto Design

30 PREDESIGNED CONFIGURATIONS

IN SITU 2-SEATERS

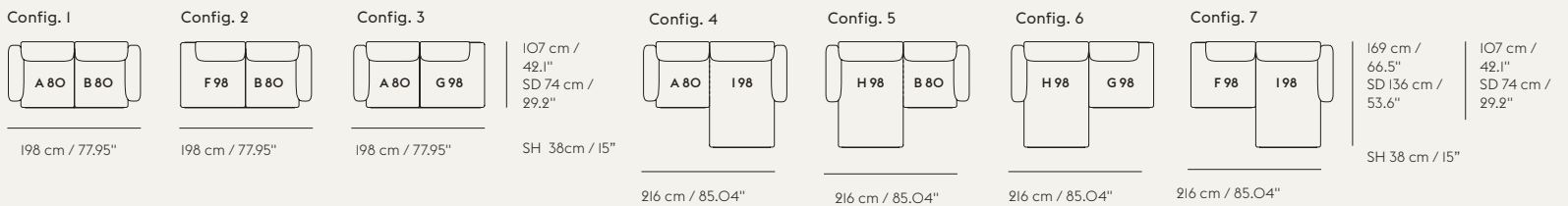

IN SITU 3-SEATERS

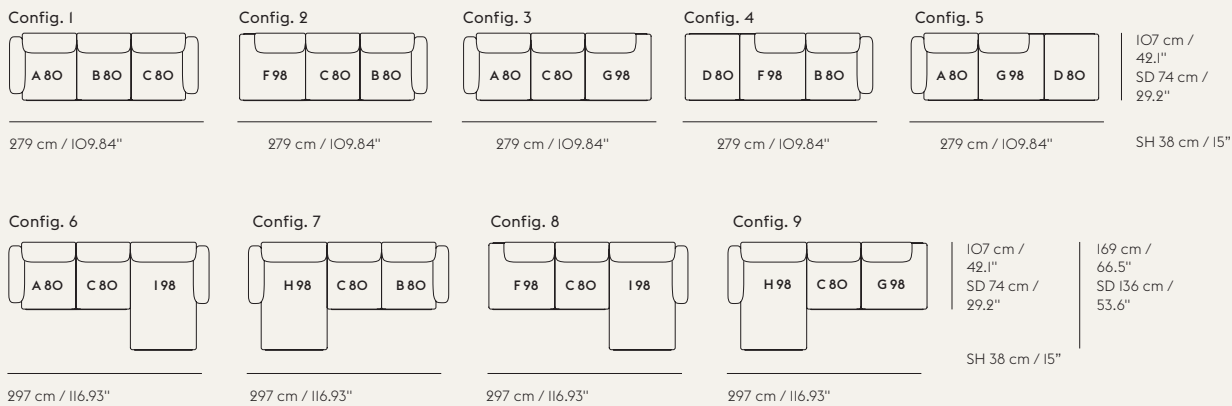

IN SITU 4-SEATERS

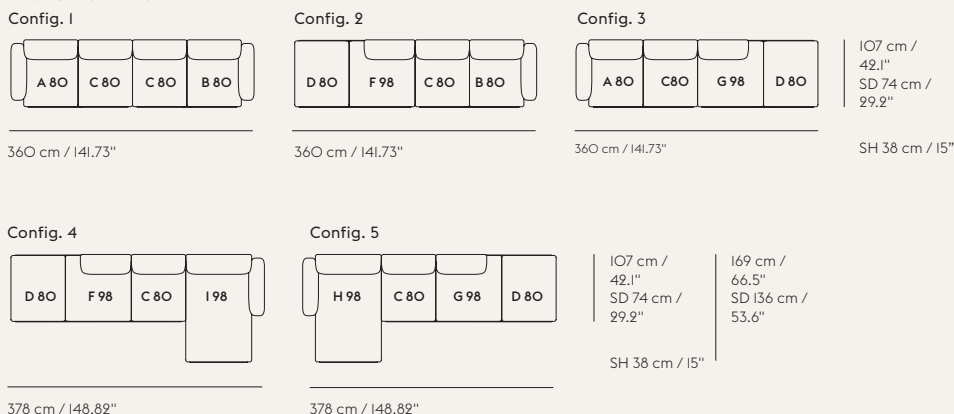

REST SOFA SERIES

by Anderssen & Voll

3-Seater

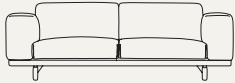

260 cm / 102.5"

3-Seater

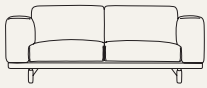

200 cm / 78.75"

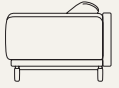

72 cm / 28.75"
SH 42 cm / 16.5"

92 cm / 36.25"

Studio Sofa

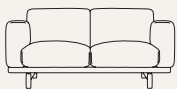

165 cm / 65"



72 cm / 28.75"
SH 42 cm / 16.5"

87 cm / 34.25"

Pouf



42 cm / 16.5"

100 cm / 39.5" 80 cm / 36.25"

READY-TO-SHIP OPTIONS

Textile Upholstery/Base



Hallingdal 457/ Oak Steelcut Trio 133/ Oak Remix 163/ Oak Vancouver 13/ Oak



Wooly IO42/ Oak

P. 55 Rest Sofa 3-Seater Steelcut Trio 713/Oak

MATERIAL

Steel base, wooden frame, cold foam and feather filling. Base in natural or painted grey or black oak. All textiles from Kvadrat, Nevotex and Arve

MADE-TO-ORDER OPTIONS

The Rest Studio Sofa and Pouf are made-to-order versions. Other approved textile upholstery available as made-to-order

PRICE

3-Seater from € 3,495 / £ 3,549 / DKK 24,995 / SEK 33,995 / NOK 33,995 / USD 4,249 / CAD 5,549

2-Seater from € 2,995 / £ 3,049 / DKK 22,495 / SEK 30,495 / NOK 30,495 / USD 3,749 / CAD 4,895

Studio Sofa from € 2,595 / £ 2,495 / DKK 19,495 / SEK 26,495 / NOK 26,495 / USD 3,195 / CAD 4,149

Pouf from € 1,095 / £ 1,095 / DKK 7,649 / SEK 10,495 / NOK 10,495 / USD 1,349 / CAD 1,749

Please note that the Ready-To-Ship Options may be subject to regional stock. Consult your Muuto dealer or refer to price list for further information

OSLO SOFA SERIES

by Anderssen & Voll

3-Seater

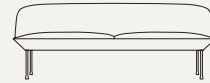

200 cm / 78.75"

2-Seater

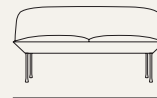

150 cm / 59"



78 cm / 30.75"
SH 42 cm / 16.5"

73 cm / 28.75"

Lounge Chair

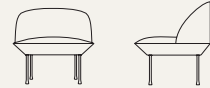

78 cm / 30.75"
SH 42 cm / 16.5"

80 cm / 31.5" 73 cm / 28.75"

Bench



150 cm / 59" 73 cm / 28.75"

Pouf



42 cm / 16.5"

100 cm / 39.5" 73 cm / 28.75"

Please note that the Ready-To-Ship Options may be subject to regional stock. Consult your Muuto dealer or refer to price list for further information

READY-TO-SHIP OPTIONS

Textile Upholstery/Base



Steelcut 180/ Dark Grey Steelcut Trio 966/ Dark Grey Fiord 151/ Dark Grey Fiord 551/ Light Grey

MATERIAL

Inner steel frame, base in powder coated aluminum and casted foam. All textiles from Kvadrat

MADE-TO-ORDER OPTIONS

The Oslo Bench and Pouf are made-to-order. Other approved textiles and leather available as made-to-order. Option of Dark Grey, Light Grey, Black, Burnt Yellow, Navy Blue or Chrome legs

PRICE

3-Seater from € 2,949 / £ 2,649 / DKK 21,995 / SEK 29,995 / NOK 29,995 / USD 3,695 / CAD 4,795

2-seater from € 2,495 / £ 2,249 / DKK 18,995 / SEK 25,995 / NOK 25,995 / USD 3,149 / CAD 4,049

Lounge Chair from € 1,695 / £ 1,495 / DKK 12,495 / SEK 16,995 / NOK 16,995 / USD 2,149 / CAD 2,749

Pouf from € 1,195 / £ 1,049 / DKK 8,995 / SEK 12,495 / NOK 12,495 / USD 1,495 / CAD 1,949

Bench from € 1,595 / £ 1,449 / DKK 11,995 / SEK 16,495 / NOK 16,495 / USD 1,995 / CAD 2,595

CONNECT MODULAR SOFA

by Anderssen & Voll

End modules



92 cm / 36.25"

117 cm / 46"



117 cm / 46"



117 cm / 46"



117 cm / 46"

92 cm / 36.25"

Center & corner modules



117 cm / 46"



92 cm / 36.25"

92 cm / 36.25"



92 cm / 36.25"

End & lounge modules

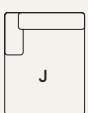

117 cm / 46"



117 cm / 46"

150 cm / 59"

Freestanding modules



117 cm / 46"



92 cm / 36.25"

92 cm / 36.25"

Inspiration for your Connect Modular Sofa

234 cm / 92"



326 cm / 128"

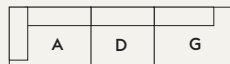

326 cm / 128"

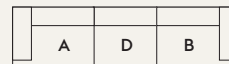

326 cm / 128"

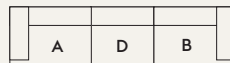

351 cm / 138"

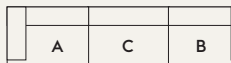

234 cm / 92"

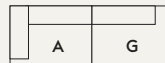

234 cm / 92"

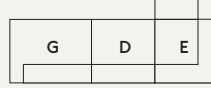

351 cm / 138"

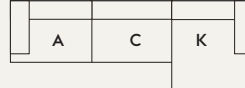

301 cm / 119"

READY-TO-SHIP OPTIONS



Remix 123 Vancouver 13

P. 50 Connect Modular Sofa Remix 123

MATERIAL

Cold foam, wooden frame. All textiles from Kvadrat, Nevotex, Fidentessile and Arve

MADE-TO-ORDER OPTIONS

Combine your sofa setup from 11 different modules. Modules H, I, J & K are made-to-order. Other approved textiles are available as made-to-order

PRICE

End modules from € 1,279 / £ 1,349 / DKK 9,695 / SEK 13,495 / NOK 13,495 / USD 1,595 / CAD 2,049

Center & corner modules from € 1,129 / £ 1,195 / DKK 8,195 / SEK 11,000 / NOK 11,000 / USD 1,395 / CAD 1,795

End & lounge modules from € 1,995 / £ 1,995 / DKK 14,995 / SEK 20,495 / NOK 20,495 / USD 2,449 / CAD 3,195

Freestanding modules from € 815 / £ 745 / DKK 6,149 / SEK 8,295 / NOK 8,295 / USD 995 / CAD 1,295

Please note that the Ready-To-Ship Options may be subject to regional stock. Consult your Muuto dealer or refer to price list for further information

COMPOSE SOFA SERIES

by Anderssen & Voll

3-Seater

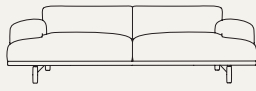

240 cm / 94.5"

2-Seater

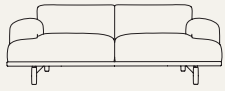

200 cm / 78.75"

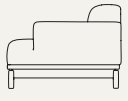

69 cm / 27.25"
SH 38 cm / 15"

94 cm / 37"

MATERIAL

Wooden frame, steel rails and cold-foam filling. Base in natural or black lacquered oak. All textiles from Kvadrat, Fidertessile, Nevotex or Arve

MADE-TO-ORDER OPTIONS

The entire Compose Sofa series is made-to-order. Other approved textiles are available as made-to-order

PRICE

3-Seater from € 3,095 / £ 3,049 / DKK 23,995 / SEK 32,495 / NOK 32,495 / USD 3,749 / CAD 4,895

2-Seater from € 2,695 / £ 2,695 / DKK 19,995 / SEK 26,995 / NOK 26,995 / USD 3,149 / CAD 4,049

DOZE LOUNGE CHAIR & OTTOMAN

by Anderssen & Voll

Chair



106 cm / 41.7"
SH 40 cm / 15.8"

95,5 cm / 37,6"

100 cm / 39,4"

Ottoman



40 cm / 15.8"

64 cm / 25.2"

52 cm / 20.5"

P. 18 Doze Lounge Chair & Ottoman Forest Nap 952/Dusty Green

P. 26 Doze Lounge Chair & Ottoman Refine Leather Cognac/Anthracite Black

READY-TO-SHIP OPTIONS

Textile Upholstery/Base

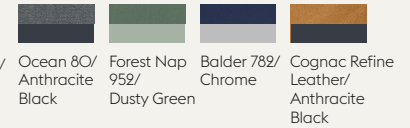

MADE-TO-ORDER INSPIRATION

Textile Upholstery/Base

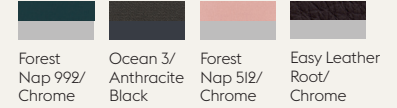

MATERIAL

Steel construction with moulded foam filling

MADE-TO-ORDER OPTIONS

Other approved textile or leather upholsteries available as made-to-order

PRICE

Chair from € 1,995 / £ 1,895 / DKK 14,995 / SEK 20,495 / NOK 20,495 / USD 2,495 / CAD 3,249

Ottoman from € 695 / £ 645 / DKK 4,995 / SEK 6,749 / NOK 6,749 / USD 869 / CAD 1,149

Please note that the Ready-To-Ship Options may be subject to regional stock. Consult your Muuto dealer or refer to price list for further information

FIVE POUF

by Anderssen & Voll

Large

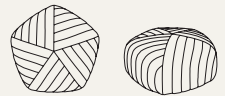

45 cm / 17.75"

88 cm / 34.5" 53 cm / 21"

Extra Large

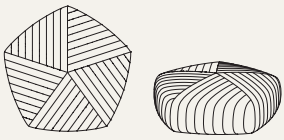

45 cm / 17.75"

140 cm / 55"

85 cm / 33.5"

READY-TO-SHIP OPTIONS

Five Pouf Large



MATERIAL

Wooden frame and molded foam. All textiles from Kvadrat

MADE-TO-ORDER OPTIONS

Extra Large Pouf and other approved textiles are available as made-to-order options

PRICE

Extra Large from € 1,949 / £ 1,795 / DKK 14,495 / SEK 19,495 / NOK 19,495 / USD 2,395 / CAD 3,095

Large from € 895 / £ 895 / DKK 6,995 / SEK 9,395 / NOK 9,395 / USD 1,149 / CAD 1,495

Please note that the Ready-To-Ship Options may be subject to regional stock. Consult your Muuto dealer or refer to price list for further information

ECHO POUF

by Anderssen & Voll



39 cm / 15.4"

62 cm / 24.4"

42 cm / 16.5"



39 cm / 15.4"

52 cm / 20.5"

52 cm / 20.5"

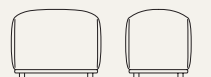

39 cm / 15.4"

52 cm / 20.5"

38 cm / 15"

MADE-TO-ORDER INSPIRATION

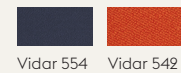
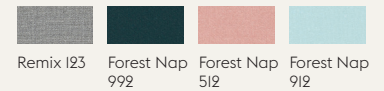

MATERIAL

Black wood frame and High-Resilience foam

MADE-TO-ORDER OPTIONS

All Echo Pouf versions are made-to-order. Other approved textiles are available as made-to-order for the entire series

PRICE

42 x 62 from € 649 / £ 585 / DKK 4,795 / SEK 6,449 / NOK 6,449 / USD 845 / CAD 1,095

52 x 52 from € 575 / £ 519 / DKK 4,295 / SEK 5,795 / NOK 5,795 / USD 745 / CAD 965

38 x 52 from € 549 / £ 495 / DKK 3,995 / SEK 5,395 / NOK 5,395 / USD 685 / CAD 889

P. 43 Echo Pouf Vidar 542, Forest Nap 912 & Forest Nap 992

WORKSHOP TABLE

by Cecilie Manz



140 cm / 55.1"



92 cm / 36.2"



200 cm / 78.7"



92 cm / 36.2"

READY-TO-SHIP OPTIONS



Oak Veneer/
Oak Warm Grey
Linoleum/
Oak

MATERIAL

Frame and legs are made from lacquered solid oak. Table top with a lacquered oak veneer or linoleum finish

PRICE

140 x 92 from € 1,395 / £ 1,295 / DKK 9,995 / SEK 13,495 / NOK 13,495 / USD 1,749 / CAD 2,295

200 x 92 from € 1,895 / £ 1,749 / DKK 13,995 / SEK 18,995 / NOK 18,995 / USD 2,395 / CAD 3,095

BASE TABLE RECTANGULAR & ROUND

by Mika Tolvanen

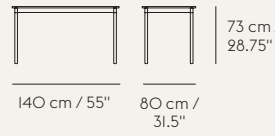

140 cm / 55"

80 cm / 31.5"

73 cm / 28.75"

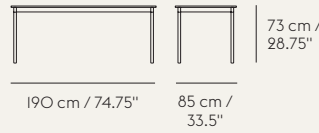

190 cm / 74.75"

85 cm / 33.5"

73 cm / 28.75"

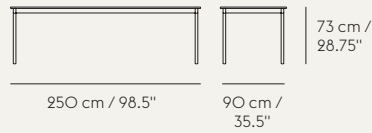

250 cm / 98.5"

90 cm / 35.5"

73 cm / 28.75"

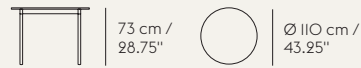

73 cm / 28.75"

Ø 110 cm / 43.25"

READY-TO-SHIP OPTIONS

Tabletop

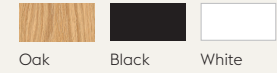

Oak

Black

White

Frame

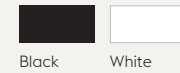

Black

White

MATERIAL

Frame in extruded aluminum with legs and stretcher in steel. Tabletop in either chip board with laminate surface and ABS edges, in plywood with linoleum surface or oak with veneer finish

MADE-TO-ORDER OPTIONS

More sizes available as made-to-order versions. Tabletop finish in nanolaminate available as made-to-order in the colors Black or White

PRICE

250 x 90 from € 1,429 / £ 1,395 / DKK 10,795 / SEK 14,495 / NOK 14,495 / USD 1,695 / CAD 2,195

190 x 85 from € 989 / £ 889 / DKK 7,295 / SEK 9,795 / NOK 9,795 / USD 1,195 / CAD 1,549

140 x 80 from € 935 / £ 845 / DKK 6,895 / SEK 9,295 / NOK 9,295 / USD 1,149 / CAD 1,495

Ø110 from € 965 / £ 869 / DKK 7,095 / SEK 9,549 / NOK 9,549 / USD 1,195 / CAD 1,495

70/70 TABLE

by TAF Studio

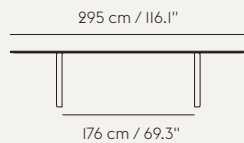

295 cm / 116.1"

176 cm / 69.3"



73 cm / 28.75"

108 cm / 42.5"

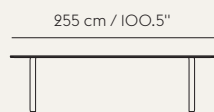

255 cm / 100.5"



73 cm / 28.75"

108 cm / 42.5"

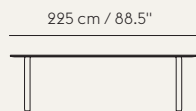

225 cm / 88.5"

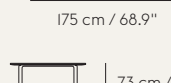

73 cm / 28.75"

90 cm / 35.5"

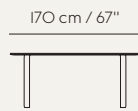

170 cm / 67"

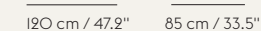

73 cm / 28.75"

120 cm / 47.2"

85 cm / 33.5"

READY-TO-SHIP OPTIONS

Tabletop



Black

Grey

White

Sand

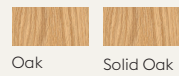

Oak

Solid Oak

Frame



Black

Grey

White

Sand

MATERIAL

Black & Grey: Cast aluminum frame. Plywood tabletop with linoleum surface and lacquered oak veneer. White version: Cast aluminum frame. Plywood tabletop with laminate surface and lacquered oak veneer. Solid Oak version: Cast aluminum frame. Tabletop in solid oiled oak.

MADE-TO-ORDER OPTIONS

Tabletop finish in nanolaminate available as made-to-order in the colors Black, White and Grey

PRICE

295 x 108 from € 2,049 / £ 1,849 / DKK 15,495 / SEK 20,995 / NOK 20,995 / USD 2,495 / CAD 3,249

255 x 108 from € 1,895 / £ 1,749 / DKK 14,495 / SEK 19,495 / NOK 19,495 / USD 2,349 / CAD 2,995

225 x 90 from € 1,695 / £ 1,549 / DKK 12,995 / SEK 17,495 / NOK 17,495 / USD 2,095 / CAD 2,695

170 x 85 from € 1,249 / £ 1,149 / DKK 9,695 / SEK 13,495 / NOK 13,495 / USD 1,495 / CAD 1,949

LINEAR WOOD SERIES

by Thomas Bentzen

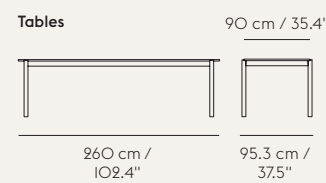

260 cm / 102.4"

90 cm / 35.4"

74 cm / 29.1"

95.3 cm / 37.5"

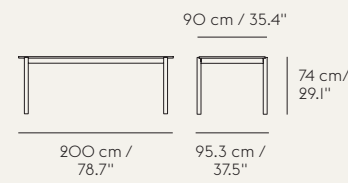

200 cm / 78.7"

90 cm / 35.4"

74 cm / 29.1"

95.3 cm / 37.5"

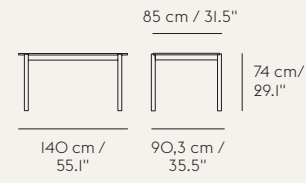

140 cm / 55.1"

85 cm / 31.5"

74 cm / 29.1"

90.3 cm / 35.5"

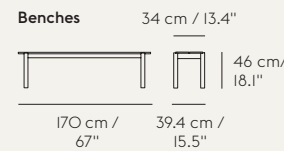

170 cm / 67"

34 cm / 13.4"

46 cm / 18.1"

39.4 cm / 15.5"

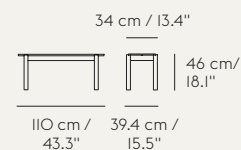

110 cm / 43.3"

34 cm / 13.4"

46 cm / 18.1"

39.4 cm / 15.5"

READY-TO-SHIP OPTIONS



Oak

MATERIAL

Top in lacquered oak veneer with solid oak legs

PRICE

Table 260 x 90 € 1,495 / £ 1,349 / DKK 10,995 / SEK 14,995 / NOK 14,995 / USD 1,895 / CAD 2,449

Table 200 x 90 € 1,295 / £ 1,195 / DKK 9,995 / SEK 13,495 / NOK 13,495 / USD 1,649 / CAD 2,149

Table 140 x 85 € 995 / £ 895 / DKK 7,495 / SEK 10,495 / NOK 10,495 / USD 1,249 / CAD 1,649

Bench 170 x 34 € 695 / £ 625 / DKK 4,995 / SEK 6,995 / NOK 6,749 / USD 869 / CAD 1,149

Bench 110 x 34 € 495 / £ 445 / DKK 3,995 / SEK 5,495 / NOK 5,395 / USD 619 / CAD 805

LINEAR STEEL TABLE

by Thomas Bentzen

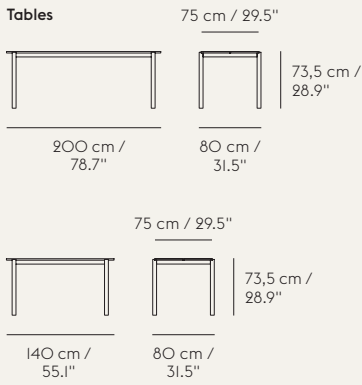

MATERIAL
Frame and table top are made from steel with a weather-resistant deep matt, UV-resistant powder coated finish. Table top is aluzinc while legs are galvanized treated, making them suitable for outdoor use. Legs come with plastic glides.

PRICE
Table 200 x 75 € 1.095 / £ 985 / DKK 7.995 / SEK 10.995 / NOK 10.495 / USD 1,395 / CAD 1,795

Table 140 x 75 € 949 / £ 855 / DKK 6.995 / SEK 9.395 / NOK 8.849 / USD 1,195 / CAD 1,549

LINEAR STEEL CAFÉ TABLE

by Thomas Bentzen

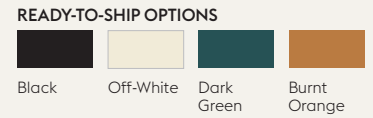
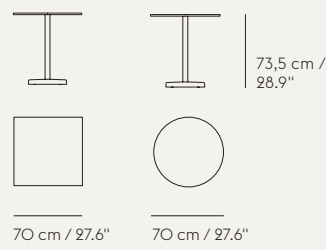

MATERIAL
The tabletop and base are made from galvanized steel with a weather-resistant deep matt, UV-resistant powder coated finish, making the table suitable for outdoor use. Plastic glides for outdoor use.

PRICE
€ 475 / £ 429 / DKK 3.495 / SEK 4.695 / NOK 4.695 / USD 595 / CAD 775

LINEAR STEEL BENCH

by Thomas Bentzen

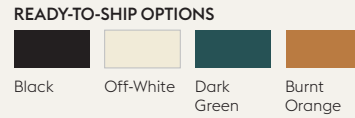
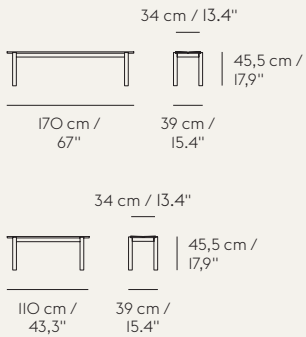

MATERIAL
Frame and seat are made from steel with a weather-resistant deep matt, UV-resistant powder coated finish. Seat is aluzinc while legs are galvanized treated, making them suitable for outdoor use. Legs come with plastic glides.

PRICE
Bench 170 x 34 € 675 / £ 609 / DKK 4.995 / SEK 6.749 / NOK 6.295 / USD 845 / CAD 1,095

Bench 110 x 34 € 495 / £ 445 / DKK 3.795 / SEK 5.095 / NOK 4.795 / USD 619 / CAD 805

LINEAR STEEL ARMCHAIR & SIDE CHAIR

by Thomas Bentzen

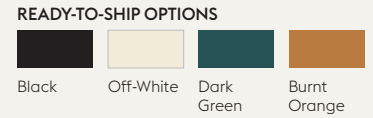

MATERIAL
The chair is made from galvanized steel with a weather-resistant deep matt, UV-resistant powder coated finish, making the chair suitable for outdoor use. Plastic glides for outdoor use.

PRICE
Armchair € 275 / £ 249 / DKK 1.995 / SEK 2.695 / NOK 2.695 / USD 335 / CAD 439

Side Chair € 269 / £ 245 / DKK 1.895 / SEK 2.549 / NOK 2.549 / USD 315 / CAD 405

LINEAR STEEL CHAIR & BENCH SEAT PAD

by Thomas Bentzen

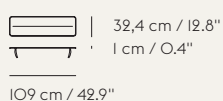

MATERIAL
Upholstered foam with black, anti-slip backing. Upholstered in UV protected polyester textile.

PRICE
Bench Seat Pad 110 cm € 95 / £ 109 / DKK 695 / SEK 935 / NOK 935 / USD 119 / CAD 155

Bench Seat Pad 170 cm € 129 / £ 145 / DKK 995 / SEK 1.349 / NOK 1.349 / USD 165 / CAD 209

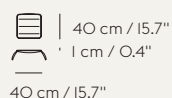

Chair Seat Pad € 49 / £ 55 / DKK 349 / SEK 469 / NOK 469 / USD 65 / CAD 79

LINEAR STEEL COVER

by Thomas Bentzen



MATERIAL
PVC coated polyester. Suitable for outdoor use.

PRICE
For table size 140 x 75 € 79 / £ 75 / DKK 595 / SEK 799 / NOK 799 / USD 99 / CAD 129

For table size 200 x 75 € 89 / £ 85 / DKK 695 / SEK 935 / NOK 935 / USD 115 / CAD 145



STILL CAFÉ TABLE

by Iskos-Berlin

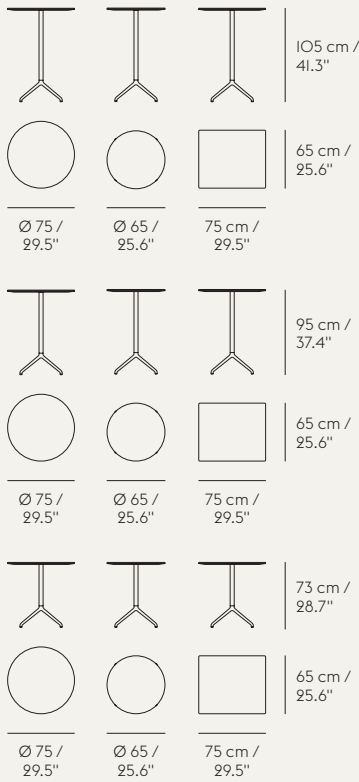

READY-TO-SHIP OPTIONS



MATERIAL

Tabletop in MDF with the option of nanolaminate or linoleum finish. Edges are painted. Frame in powder coated aluminum. Mounting plate and tube in powder coated steel. Comes with 4 adjustable feet in plastic

MADE-TO-ORDER OPTIONS

Linoleum surface is made-to-order. Tabletop in size Ø65 is available as made-to-order

PRICE

Ø75 & Ø65 H:105 € 549 / £ 495 / DKK 4.095 / SEK 5.549 / NOK 5.549 / USD 625 / CAD 809

Ø75 & Ø65 H:95 € 549 / £ 495 / DKK 4.095 / SEK 5.549 / NOK 5.549 / USD 625 / CAD 809

Ø75 & Ø65 H:73 from € 499 / £ 449 / DKK 3.795 / SEK 5.095 / NOK 5.095 / USD 565 / CAD 729

75 x 65 H:105 € 549 / £ 495 / DKK 4.095 / SEK 5.549 / NOK 5.549 / USD 625 / CAD 809

75 x 65 H:95 € 549 / £ 495 / DKK 4.095 / SEK 5.549 / NOK 5.549 / USD 625 / CAD 809

75 x 65 H:73 from € 499 / £ 449 / DKK 3.795 / SEK 5.095 / NOK 5.095 / USD 565 / CAD 729

WORKSHOP COFFEE TABLE

by Cecilie Manz

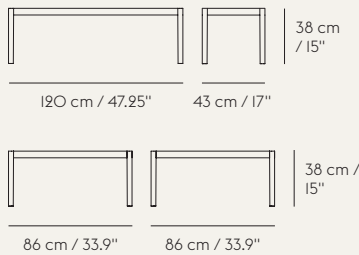

READY-TO-SHIP OPTIONS

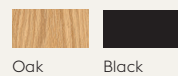

MATERIAL

Legs and frame in solid wood. Tabletop in oak veneer. Black version comes in a lacquered oak. Oak version comes with a matte clear lacquer

PRICE

120 x 43 € 549 / £ 495 / DKK 3.995 / SEK 5.395 / NOK 5.395 / USD 685 / CAD 889

86 x 86 € 675 / £ 609 / DKK 4.995 / SEK 6.749 / NOK 6.749 / USD 845 / CAD 1,095

RELATE SIDE TABLE

by Big-Game

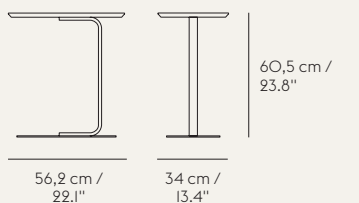

READY-TO-SHIP OPTIONS

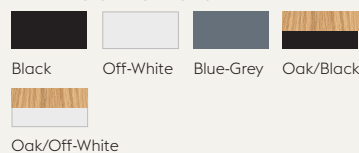

MATERIAL

Black, Off-White and Blue-Grey linoleum finish on MDF or high pressure laminate oak veneer on MDF. Frame in powder coated steel

PRICE

Oak veneer € 399 / £ 359 / DKK 2.995 / SEK 3.995 / NOK 4.049 / USD 499 / CAD 649

Linoleum € 375 / £ 339 / DKK 2.695 / SEK 3.649 / NOK 3.649 / USD 435 / CAD 565

AIRY COFFEE TABLE

by Cecilie Manz

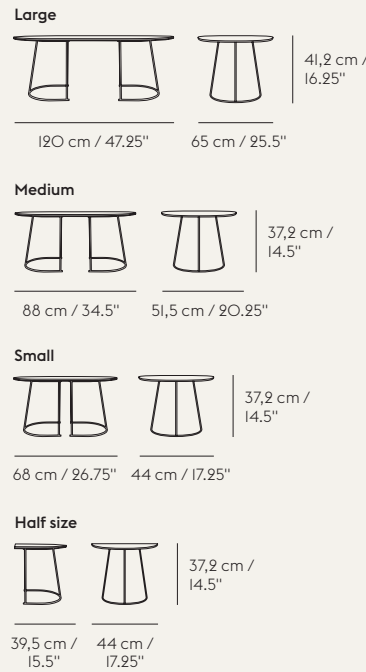

READY-TO-SHIP OPTIONS

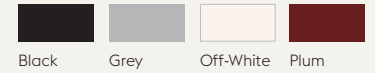

MATERIAL

Plywood tabletop with nanolaminate surface, powder coated solid steel frame

PRICE

Large € 479 / £ 435 / DKK 3.595 / SEK 4.849 / NOK 4.849 / USD 585 / CAD 765

Medium € 379 / £ 3245 / DKK 2.695 / SEK 3.649 / NOK 3.649 / USD 435 / CAD 565

Small € 299 / £ 269 / DKK 2.295 / SEK 3.095 / NOK 3.095 / USD 349 / CAD 455

Half size € 195 / £ 175 / DKK 1.495 / SEK 2.049 / NOK 2.049 / USD 239 / CAD 309

AROUND COFFEE TABLE

by Thomas Bentzen

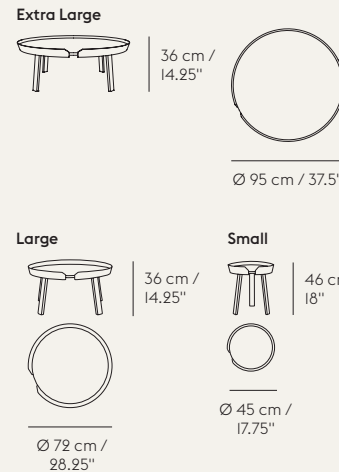

READY-TO-SHIP OPTIONS



MATERIAL

Oak tables made from oak plywood and solid oak legs with PU lacquer or water-based lacquer. Colored tables made from MDF or ash plywood and solid ash legs with PU lacquer or water-based lacquer.

PRICE

Extra Large € 815 / £ 735 / DKK 5.649 / SEK 7.595 / NOK 7.595 / USD 995 / CAD 1,295

Large € 559 / £ 505 / DKK 4.295 / SEK 5.795 / NOK 5.795 / USD 699 / CAD 889

Small € 359 / £ 325 / DKK 2.549 / SEK 3.449 / NOK 3.449 / USD 459 / CAD 565

HALVES SIDE TABLE

by MSDS Studio

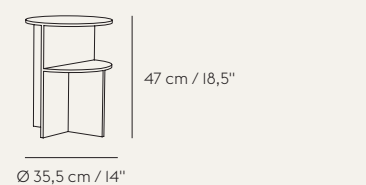

READY-TO-SHIP OPTIONS



MATERIAL

Acrylic stone composite

PRICE

€ 339 / £ 305 / DKK 2.449 / SEK 3.295 / NOK 3.295 / USD 499 / CAD 649

FLOW TROLLEY
by Normal Studio

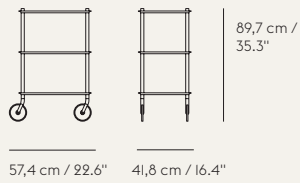

MATERIAL
Trays and legs in powder coated steel.
Wheels in powder coated steel and rubber.

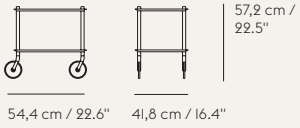

PRICE
2-Layer € 339 / £ 305 / DKK 2.495 / SEK 3.349 / NOK 3.349 / USD 519 / CAD 675

3-Layer € 469 / £ 425 / DKK 3.495 / SEK 4.695 / NOK 4.695 / USD 719 / CAD 929

MINI STACKED STORAGE SYSTEM
by Julien De Smedt

Inspiration for your Mini Stacked Storage System

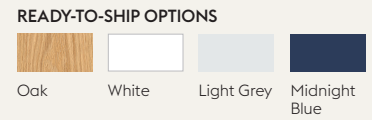
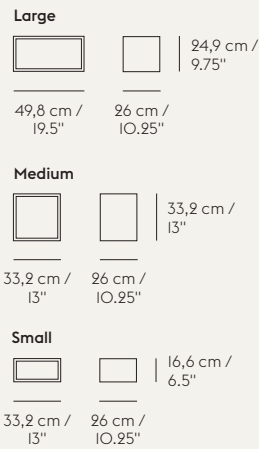
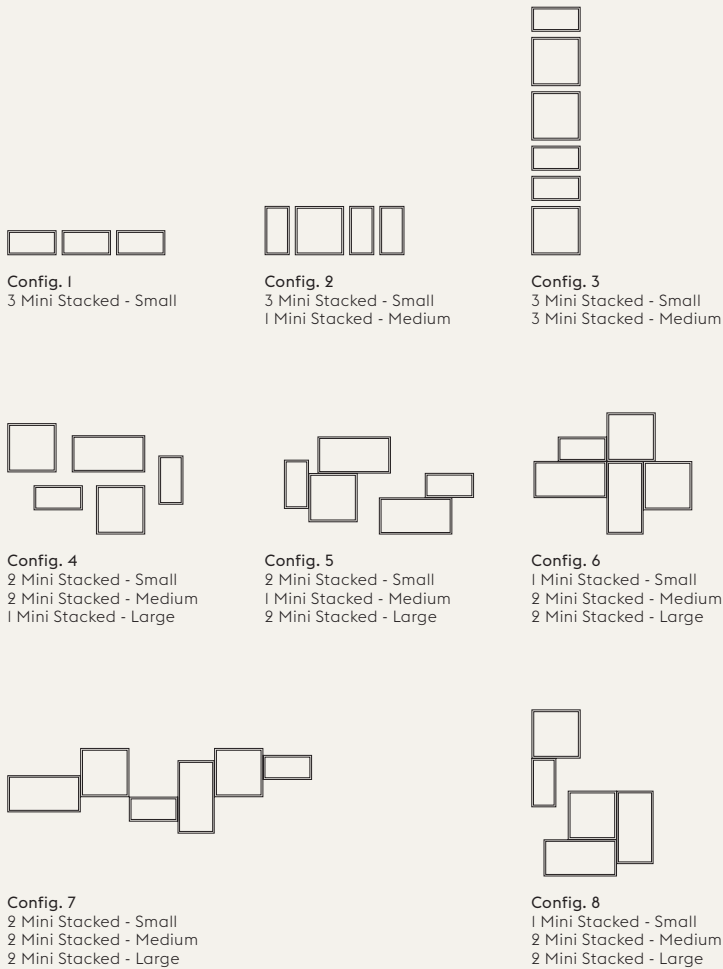

Colored backboard (only medium)



MATERIAL
Oak veneer or PU lacquered MDF.
Clips in painted steel

EXTRA
Each Mini Stacked module comes with one clip. Extra clips available in Set of 5 in the colors White, Dusty Green, Light Grey and Midnight Blue.

PRICE
Large € 149 / £ 135 / DKK 1.095 / SEK 1.449 / NOK 1.495 / USD 189 / CAD 245

Medium € 135 / £ 125 / DKK 995 / SEK 1.295 / NOK 1.349 / USD 169 / CAD 219

Small € 119 / £ 109 / DKK 895 / SEK 1.195 / NOK 1.249 / USD 149 / CAD 195

Clip Set of 5 € 20 / £ 18 / DKK 150 / SEK 195 / NOK 205 / USD 25 / CAD 33

Find recommended retail prices for all configurations on muuto.com

Design your own Mini Stacked solution on muuto.com
All shown settings and pre-arranged configurations are tested according to European safety standards. Clips are not shown on the drawings. Please follow assembly instruction & configuration guidelines. All indicated dimensions are non-binding and are subject to the right of modification at any time.

STACKED STORAGE SYSTEM

by Julien De Smedt

Inspiration for your Stacked Storage System

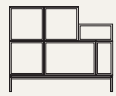

Config. 1
1 Small
1 Small w/ backboard
1 Medium
2 Medium w/ door
1 Large
1 Podium



Config. 2
2 Small w/ backboard
1 Medium w/ backboard
2 Medium w/ door
2 Large
1 Podium

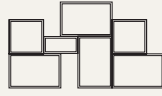

Config. 3
1 Small
2 Medium w/ backboard
2 Large
2 Large w/ backboard

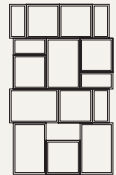

Config. 4
3 Small w/ backboard
2 Medium w/ backboard
3 Large w/ backboard
3 Small
2 Medium
1 Large
2 Medium w/ door

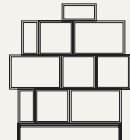

Config. 5
3 Small
3 Medium
1 Medium w/ backboard
1 Large
2 Large w/ backboard
1 Podium

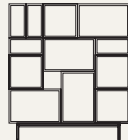

Config. 6
2 Small
2 Small w/ backboard
1 Medium
3 Medium w/ door
2 Large
2 Large w/ backboard
1 Podium

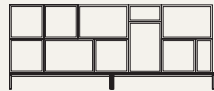

Config. 7
2 Small w/ backboard
2 Medium w/ backboard
3 Medium w/ door
4 Large w/ backboard
2 Podium



Config. 8 - Version 1*
2 Medium w/ door
3 Medium w/ backboard
5 Small w/ backboard



Config. 8 - Version 2*
2 Medium w/ door
3 Medium w/ backboard
5 Small w/ backboard



Config. 9 - Version 1*
3 Medium w/ door
6 Small w/ backboard



Config. 9 - Version 2*
3 Medium w/ door
6 Small w/ backboard

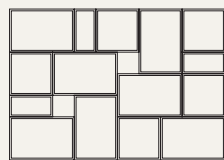

Config. 10 - Version 1*
7 Large open
5 Medium open
3 Small open

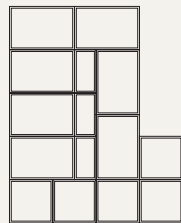

Config. 10 - Version 2*
7 Large open
5 Medium open
3 Small open

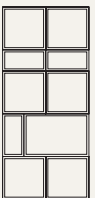

Config. 11
6 Medium w/ door
3 Small w/ backboard
1 Large w/ backboard

*Configuration 8, 9 & 10 are shown in two different versions with the same modules.

Design your own Stacked solution on muuto.com
All shown settings and pre-arranged configurations are tested according to European safety standards. Clips are not shown on the drawings. Please follow assembly instruction & configuration guidelines. All indicated dimensions are non-binding and are subject to the right of modification at any time.

Large

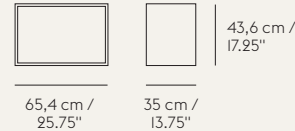

Medium

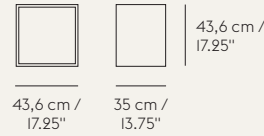

Small



Podium

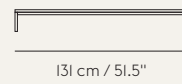

Clip

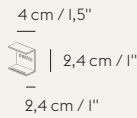

READY-TO-SHIP OPTIONS

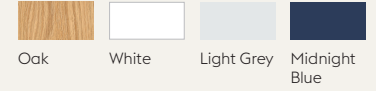

Colored backboard (only medium)



MATERIAL

Oak veneer or PU lacquered MDF.
Clips in painted steel

EXTRA

Each Stacked module comes with two clips. Extra clips available in Set of 5 in the colors White, Dusty Green, Light Grey and Midnight Blue.

PRICE

Open modules from € 129 / £ 119 / DKK 949 / SEK 1.249 / NOK 1.295 / USD 165 / CAD 209

Backboard modules from € 135 / £ 125 / DKK 995 / SEK 1.295 / NOK 1.349 / USD 169 / CAD 219

Medium modules with door from € 199 / £ 179 / DKK 1.495 / SEK 1.949 / NOK 2.049 / USD 249 / CAD 325

Podium from € 259 / £ 235 / DKK 1.895 / SEK 2.449 / NOK 2.549 / USD 325 / CAD 425

Clips Set of 5 € 20 / £ 18 / DKK 150 / SEK 195 / NOK 205 / USD 25 / CAD 33

Find recommended retail prices for all configurations on muuto.com

The Stacked Storage System complies with the European requirements for safety, strength, durability and stability within storage — EN 16121:2013 and EN 16122:2012 — when following the assembly and configuration guidelines

STACKED ACOUSTIC PANELS

by Julien De Smedt

Large



Medium

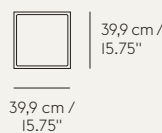

Small

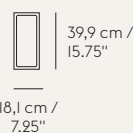

READY-TO-SHIP OPTIONS

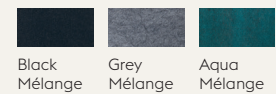

MATERIAL

Polymer felt

PRICE

Large € 50 / £ 44 / DKK 369 / SEK 469 / NOK 495 / USD 65 / CAD 85

Medium € 40 / £ 35 / DKK 299 / SEK 379 / NOK 405 / USD 50 / CAD 65

Small € 35 / £ 31 / DKK 249 / SEK 319 / NOK 335 / USD 44 / CAD 59

COMPILE SHELVING SYSTEM

by Cecilie Manz

Predefined configurations

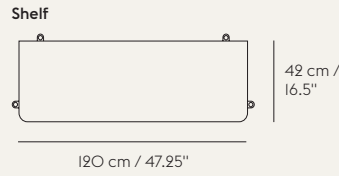
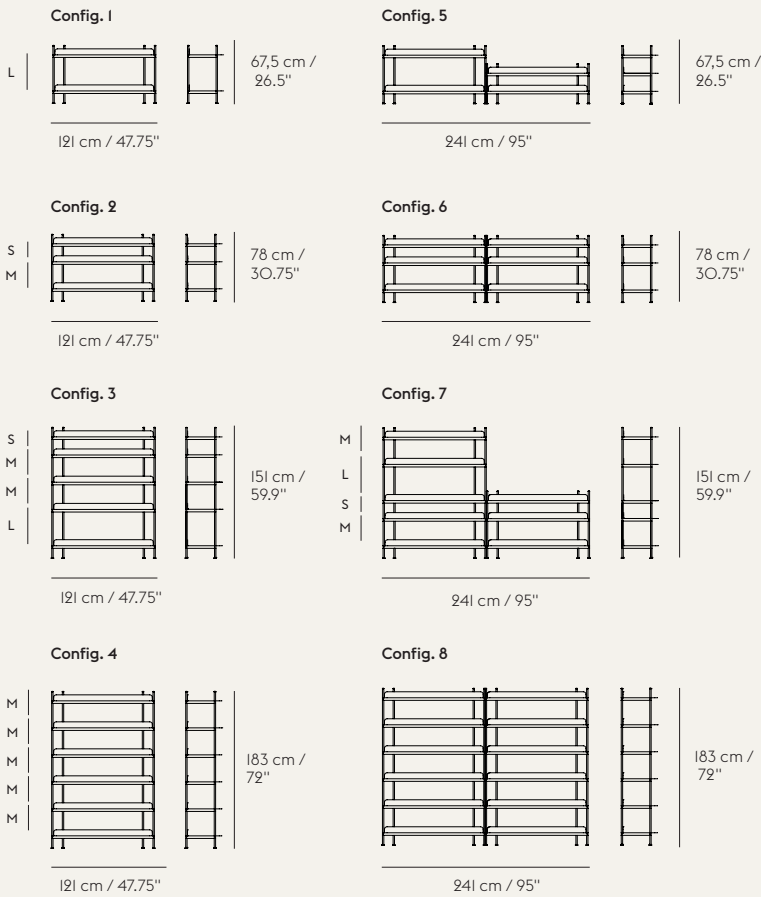

READY-TO-SHIP OPTIONS

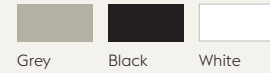

MATERIAL

Powder coated steel

MADE-TO-ORDER OPTIONS

Build personalized systems by assembling shelves with 3 sizes of dividers or choose between 8 prearranged configurations

PRICE

Shelf € 199 / £ 179 / DKK 1.495 / SEK 2.049 / NOK 2.049 / USD 219 / CAD 285

Dividers € 30 / £ 27 / DKK 200 / SEK 269 / NOK 269 / USD 38 / CAD 49

Essentials pack € 80 / £ 75 / DKK 600 / SEK 795 / NOK 805 / USD 105 / CAD 135

Config. 1 € 469 / £ 425 / DKK 3.495 / SEK 4.695 / NOK 4.695 / USD 575 / CAD 745

Config. 2 € 679 / £ 615 / DKK 4.995 / SEK 6.749 / NOK 6.749 / USD 829 / CAD 1,095

Config. 3 € 1.095 / £ 985 / DKK 7.995 / SEK 10.995 / NOK 10.995 / USD 1,349 / CAD 1.749

Config. 4 € 1.349 / £ 1.249 / DKK 9.595 / SEK 12.995 / NOK 12.995 / USD 1,595 / CAD 2,095

Config. 5 € 949 / £ 855 / DKK 6.995 / SEK 9.395 / NOK 9.395 / USD 1,149 / CAD 1,495

Config. 6 € 1.395 / £ 1,295 / DKK 9.995 / SEK 13.495 / NOK 13.495 / USD 1,695 / CAD 2,195

Config. 7 € 1.795 / £ 1,649 / DKK 13.495 / SEK 18.495 / NOK 18.495 / USD 2,195 / CAD 2,849

Config. 8 € 2.649 / £ 2,395 / DKK 19.495 / SEK 26.495 / NOK 26.495 / USD 3,195 / CAD 4,160

Dividers

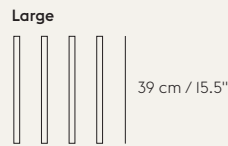

Essentials Pack

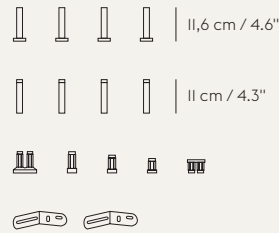

WEIGHT & HEIGHT RECOMMENDATIONS

The Compile Shelving System should always be mounted to a wall using wall brackets (included in the essentials pack). A Compile Shelving System can hold up to 300 kg / 661 lb. The Compile Shelving Systems can be built as tall as wanted, as long as it is mounted to the wall using wall brackets. Muuto recommends not building configurations higher than 2,25 m / 88,5"

ENFOLD SIDEBORD

by Thomas Bentzen

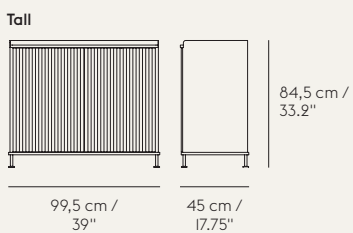

READY-TO-SHIP OPTIONS

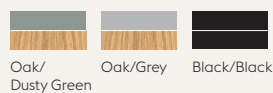

MATERIAL

Body, shelves and sliding doors in lacquered, bended steel. Top and base in solid oak with a matte lacquer

MADE-TO-ORDER OPTIONS

Other colors combinations from Oak, Dusty Green, Grey or Black as well as Sand Yellow available as made-to-order

PRICE

Tall & Low from € 1.695 / £ 1,549 / DKK 12.495 / SEK 16.995 / NOK 16.995 / USD 2,149 / CAD 2,749

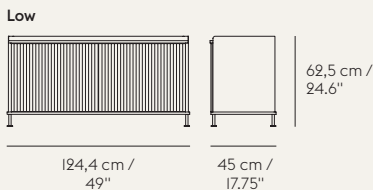

REFLECT SIDEBORD & DRAWER

by Søren Rose Studio

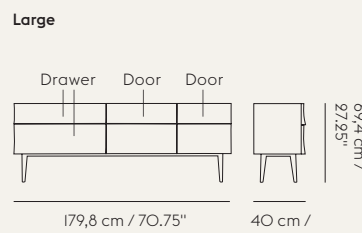

READY-TO-SHIP OPTIONS

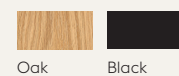

MATERIAL

Board with oak veneer and solid oak legs

PRICE

Sideboard large € 2.995 / £ 2,695 / DKK 22.495 / SEK 30.495 / NOK 30.495 / USD 3,695 / CAD 4,795

Sideboard small € 1.995 / £ 1,795 / DKK 14.995 / SEK 20.495 / NOK 20.495 / USD 2,495 / CAD 3,249

Drawer € 2.349 / £ 2,149 / DKK 17.495 / SEK 23.495 / NOK 23.495 / USD 2.895 / CAD 3,749

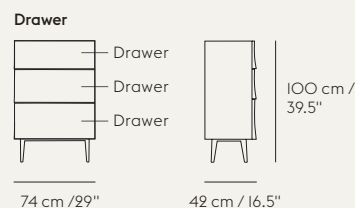
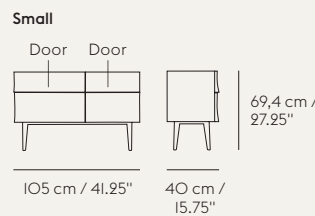

Please note that the Reflect Drawer is not available for sale in North America

LIGHTING

STRAND PENDANT LAMP

by Benjamin Hubert



60,8 cm / 23,9"

Closed Ø 80 cm / 31.5"



54,8 cm / 21.6"

Closed Ø 60 cm / 23.6"

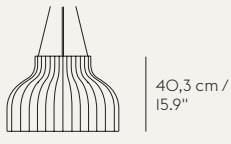

40,3 cm / 15.9"

Open Ø 60 cm / 23.6"

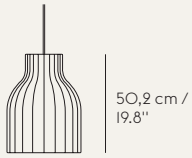

50,2 cm / 19.8"

Open Ø 40 cm / 15.7"



37,4 cm / 14.7"

Open Ø 28 cm / 11"



White

MATERIAL

Steel structure covered with cocoon material. PVC cord, PVC covered steel wire

LIGHT SOURCE

Ø28 & Ø40 lx E26/E27 Max. 40W
Ø60 & Ø80 lx E26/E27 Max. 60W

PRICE

Open Ø28 € 269 / £ 245 / DKK 1.995 / SEK 2.695 / NOK 2.695 / USD 335 / CAD 439

Open Ø40 € 395 / £ 355 / DKK 2.995 / SEK 4.049 / NOK 4.049 / USD 495 / CAD 645

Open Ø60 € 595 / £ 535 / DKK 4.495 / SEK 6.049 / NOK 6.049 / USD 745 / CAD 965

Closed Ø60 € 679 / £ 615 / DKK 4.995 / SEK 6.749 / NOK 6.749 / USD 849 / CAD 1,149

Closed Ø80 € 795 / £ 715 / DKK 5.995 / SEK 8.049 / NOK 8.049 / USD 995 / CAD 1,295

Please note that Strand Pendant Lamp Open Ø60, Closed Ø60 and Closed Ø80 come with a wire suspension system with three wires

RIME PENDANT LAMP

by TAF Studio



55,5 cm / 21.9"

Ø 45 cm / 17.7"

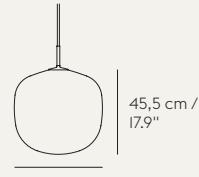

45,5 cm / 17.9"

Ø 37 cm / 14.6"

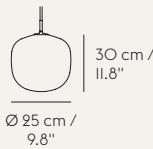

30 cm / 11.8"

Ø 25 cm / 9.8"

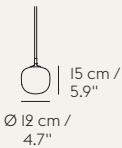

15 cm / 5.9"

Ø 12 cm / 4.7"



Black

White

Grey

Orange

MATERIAL

Mouthblown glass shade, aluminum, powder coated top-piece and pendant tube, PVC cord

LIGHT SOURCE

Ø45, Ø37 lx E26/E27 Max. 60W
Ø25 lx E12/E14 Max. 40W
Ø12 lx G9 Max 25W
EU version includes 3W frosted LED bulb

PRICE

Ø45 cm € 469 / £ 425 / DKK 3.495 / SEK 4.695 / NOK 4.695 / USD 585 / CAD 765

Ø37 cm € 399 / £ 349 / DKK 2.995 / SEK 3.995 / NOK 4.049 / USD 499 / CAD 649

Ø25 cm € 349 / £ 315 / DKK 2.495 / SEK 3.349 / NOK 3.349 / USD 435 / CAD 565

Ø12 € 199 / £ 179 / DKK 1.495 / SEK 1.995 / NOK 2.049 / USD 249 / CAD 325

AMBIT PENDANT LAMP

by TAF Studio

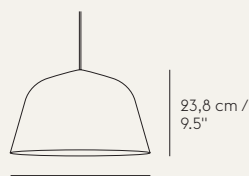

23,8 cm / 9.5"

Ø 40 cm / 15.75"



15 cm / 6"

Ø 25 cm / 9.75"



10 cm / 3.9"

Ø 16,5 cm / 6.5"

Ø 40 / Ø 25



Black

Grey

White

Dusty Green

Rose

Beige-Green

Taupe

Ø 16,5



Black

Grey

White

Taupe

Dusty Green

MATERIAL

Handspun and handpainted aluminum shade, PVC cord

LIGHT SOURCE

Ø40 lx 26/E27 Max. 60 W
Ø25 lx 26/E27 Max. 60 W
Ø16,5 cm lx GX53 Max. 12W LED
EU version includes 5,5W frosted LED bulb

PRICE

Ø40 € 375 / £ 339 / DKK 2.795 / SEK 3.795 / NOK 3.795 / USD 599 / CAD 779

Ø25 € 199 / £ 179 / DKK 1.495 / SEK 2.049 / NOK 2.049 / USD 299 / CAD 395

Ø16,5 € 149 / £ 135 / DKK 1.095 / SEK 1.495 / NOK 1.495 / USD 229 / CAD 299

Please note that Ø16,5 is not available in Beige-Green and that Ambit Pendant Lamp in Beige-Green all sizes are not available for sale in North America

AMBIT RAIL LAMP

by TAF Studio

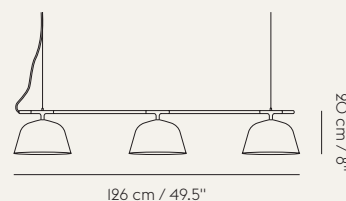

126 cm / 49.5"

90 cm / 8"



Black

Grey

White

Taupe

MATERIAL

Cast and extruded aluminum, handspun aluminum, PVC cord, steel wires

LIGHT SOURCE

3x E12/E14 Max. 60W

PRICE

€ 749 / £ 675 / DKK 5.495 / SEK 7.395 / NOK 7.395 / USD 1,149 / USD 1,495

E27 PENDANT LAMP
by Mattias Ståhlbom



MATERIAL
Silicone rubber

LIGHT SOURCE
1x E26/E27 Max. 40W
2W LED bulb included

PRICE
€ 69 / £ 65 / DKK 499 / SEK 675 / NOK 675 /
USD 105 / CAD 139

UNFOLD PENDANT LAMP
by Form Us With Love

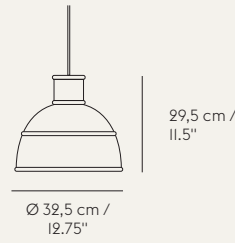

MATERIAL
Silicone rubber, PC plastic diffuser

LIGHT SOURCE
1x E26/E27 Max. 60W

PRICE
€ 175 / £ 159 / DKK 1.249 / SEK 1.695 /
NOK 1.695 / USD 269 / CAD 349

Lighting

GRAIN PENDANT LAMP
by Jens Fager



MATERIAL
Mixture of bamboo fibers and plastic,
PVC cord

LIGHT SOURCE
1x G9 Max. 5W LED
3W LED bulb included

PRICE
€ 135 / £ 125 / DKK 995 / SEK 1.349 /
NOK 1.349 / USD 209 / CAD 265

UNDER THE BELL PENDANT LAMP
by Iskos-Berlin

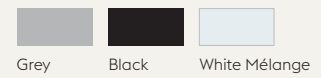
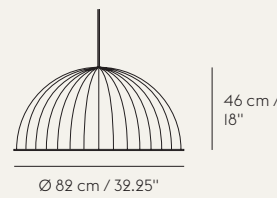

MATERIAL
PET felt made from recycled plastic, PVC
cord

LIGHT SOURCE
1x E26/E27 Max. 60W

PRICE
Ø82 € 699 / £ 629 / DKK 4.495 / SEK 5.995 /
NOK 6.049 / USD 875 / CAD 1,149

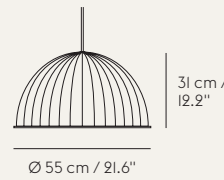

Ø55 € 499 / £ 449 / DKK 3.495 / SEK 4.695 /
NOK 4.695 / USD 735 / CAD 995

78

STUDIO PENDANT LAMP
by Thomas Bernstrand

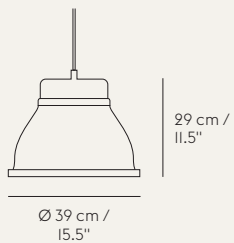

MATERIAL
Solid aluminum, rubber cord

LIGHT SOURCE
1x E26/E27 Max. 40W

PRICE
€ 349 / £ 315 / DKK 2.495 / SEK 3.349 /
NOK 3.349 / USD 435 / CAD 565

Please note that Studio Pendant Lamp is
not available for sale in North America

FLUID PENDANT LAMP
by Claesson Koivisto Rune

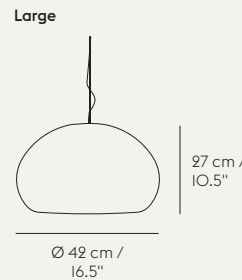

MATERIAL
Silk matt opal glass, PVC cord, metal wire

LIGHT SOURCE
Small: 1x G9 Max.40W
3W LED bulb included
Large: 1x E26/E27 Max. 60W

PRICE
Ø42 € 299 / £ 269 / DKK 2.295 / SEK 3.095 /
NOK 3.095 / USD 449 / CAD 595



€ 169 / £ 155 / DKK 1.195 / SEK 1.649 /
NOK 1.649 / USD 269 / USD 349

LINEAR PENDANT LAMP
by Thomas Bentzen

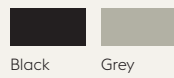
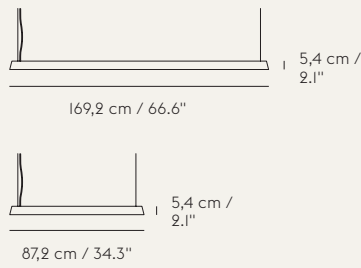

MATERIAL
Lamphead in pressure-die casted and extruded, powder coated aluminum. Stem in powder coated steel. Diffuser in polycarbonate. PVC cord

LIGHT SOURCE
87,2 cm: 20,3 W LED bulb integrated
169,2 cm: 37,7 W LED bulb integrated

PRICE
L 169,2 € 710 / £ 639 / DKK 5.295 / SEK 7.149 / NOK 6.695

L 87,2 € 535 / £ 485 / DKK 3.995 / SEK 5.395 / NOK 5.049

LINEAR TABLE LAMP
by Thomas Bentzen

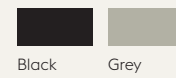

MATERIAL
Lamphead in powder coated, pressure die-casted aluminum. Stem in powder coated steel. Polycarbonate diffuser and PVC cord.

LIGHT SOURCE
6,25 W LED bulb integrated
Built-in 18W USB-C plug

PRICE
€ 375 / £ 339 / DKK 2.795 / SEK 3.795 / NOK 3.549 / USD 569 / CAD 739

TIP TABLE LAMP
by Jens Fager

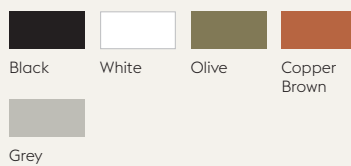

MATERIAL
Pressure die-casted aluminum, PVC cord

LIGHT SOURCE
Max. 8W LED bulb integrated, dimmable

PRICE
€ 269 / £ 245 / DKK 1.995 / SEK 2.695 / NOK 2.695 / USD 399 / CAD 535

LEAF TABLE LAMP
by Broberg & Ridderstråle

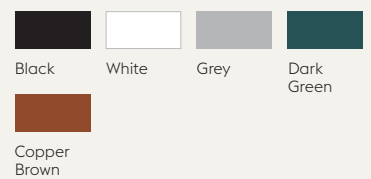
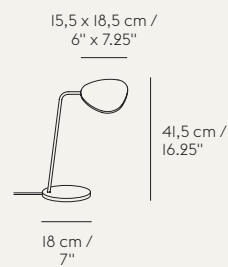

MATERIAL
Pressure die-casted aluminum, PVC cord

LIGHT SOURCE
Max. 8W LED bulb integrated, dimmable

Please note that Leaf Table Lamp in Dark Green and Copper Brown is not available for sale in Australia and New Zealand

PRICE
€ 249 / £ 225 / DKK 1.795 / SEK 2.449 / NOK 2.449 / USD 385 / CAD 495

BEAM TABLE LAMP
by Tom Chung

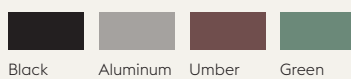
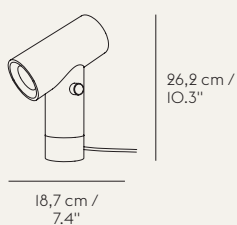

MATERIAL
Extruded anodized aluminum

LIGHT SOURCE
Max. 10,5W LED bulb integrated, dimmable

PRICE
€ 199 / £ 179 / DKK 1.495 / SEK 1.995 / NOK 2.049 / USD 299 / CAD 395

COSY IN GREY TABLE LAMP
by Harri Koskinen

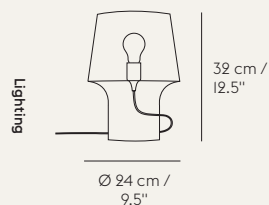

MATERIAL
Mouth-blown soda lime glass, textile cord

LIGHT SOURCE
1x E27 Max. 60W
Light source must be dimmable

PRICE
€ 229 / £ 209 / DKK 1.695 / SEK 2.295 / NOK 2.295 / USD 285 / CAD 375

Please note that Cosy In Grey Lamp is not available for sale in North America

CONTROL TABLE LAMP
by TAF Studio

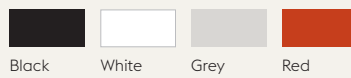
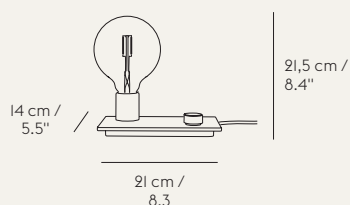

MATERIAL
Casted aluminum, PVC cord

LIGHT SOURCE
1x E26/E27 Max. 40W
Light source must be dimmable
2W LED bulb included, dimmable

PRICE
€ 149 / £ 135 / DKK 995 / SEK 1.295 / NOK 1.349 / USD 229 / CAD 299

FOCUS TABLE LAMP
by Andreas Bergsaker



MATERIAL
Turned ash wood, PVC cord

LIGHT SOURCE
1x GU10 Max. 3W
2W LED bulb integrated

PRICE
€ 159 / £ 145 / DKK 1.150 / SEK 1.549 / NOK 1.549 / USD 199 / CAD 259

Please note that Focus Table Lamp is not available for sale in North America

LEAF FLOOR LAMP
by Broberg & Ridderstråle

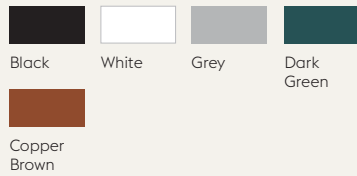
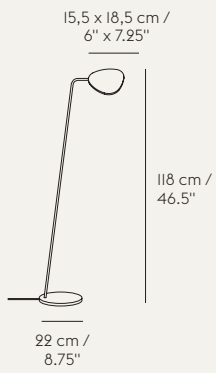

MATERIAL
Pressure die-casted aluminum, PVC cord

LIGHT SOURCE
Max. 8W LED bulb integrated, dimmable

PRICE
€ 349 / £ 315 / DKK 2.495 / SEK 3.349 /
NOK 3.349 / USD 535 / CAD 689

Please note that Leaf Floor Lamp in Dark Green and Copper Brown is not available for sale in the Asian Pacific region

PULL FLOOR LAMP
by Whatswhat

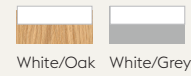
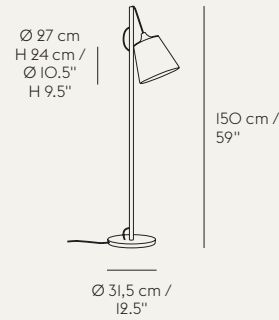

MATERIAL
Oiled oak wood or grey lacquered oak wood, 100% linen covered plastic shade, textile cord

LIGHT SOURCE
1x E26/E27 Max. 60W

PRICE
€ 469 / £ 425 / DKK 3.495 / SEK 4.695 /
NOK 4.695 / USD 569 / CAD 739

Lighting

POST FLOOR LAMP
by Earnest Studio

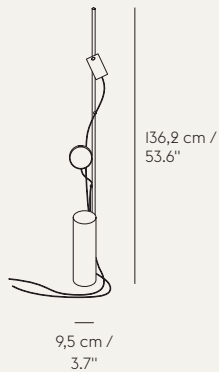

MATERIAL
Powder coated steel base, PVC cord, powder coated magnesium, acrylic opal diffuser, silicone cord, magnet with powder coated plastic

LIGHT SOURCE
Max. 13W LED bulb integrated, dimmable

PRICE
€ 599 / £ 539 / DKK 4.495 / SEK 6.049 /
NOK 6.049 / USD 925 / CAD 1,195

TIP FLOOR LAMP
by Jens Fager



MATERIAL
Pressure die-casted aluminum, PVC cord

LIGHT SOURCE
Max. 10,9W LED bulb integrated, dimmable

PRICE
€ 395 / £ 355 / DKK 2.995 / SEK 4.049 /
NOK 4.049 / USD 495 / CAD 645

80

POST WALL LAMP
by Earnest Studio

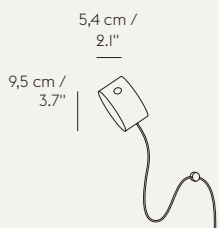

MATERIAL
Powder coated magnesium, acrylic opal diffuser, silicone cord, magnet with powder coated plastic

LIGHT SOURCE
Max. 6.7W LED bulb integrated, dimmable

PRICE
€ 249 / £ 225 / DKK 1.795 / SEK 2.449 /
NOK 2.449 / USD 375 / CAD 485

AMBIT WALL LAMP
by TAF Studio

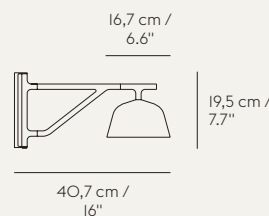

MATERIAL
Handspun aluminum, pressure die-casted aluminum, PVC cord

LIGHT SOURCE
1x GX53 Max. 12W LED
EU version includes 5,5W frosted LED bulb

PRICE
€ 349 / £ 315 / DKK 2.495 / SEK 3.349 /
NOK 3.349 / USD 535 / CAD 695

TIP WALL LAMP
by Jens Fager

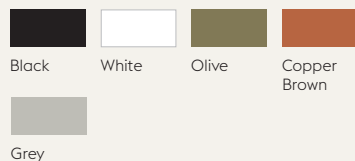
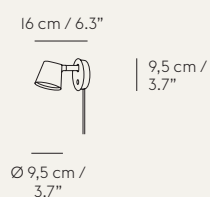

MATERIAL
Pressure die-casted aluminum, PVC cord

LIGHT SOURCE
Max. 8W LED bulb integrated, dimmable

PRICE
€ 195 / £ 175 / DKK 1.495 / SEK 2.049 /
NOK 2.049 / USD 299 / CAD 389

RIME WALL LAMP
by TAF Studio

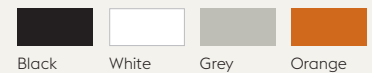
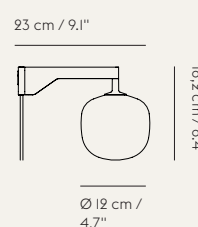

MATERIAL
Shade in mouthblown, sandblasted glass. Arm in pressure die-casted and powder-coated aluminum. Wall bracket in chrome-plated steel, PVC cord

LIGHT SOURCE
1x G9 Max. 25W
3W frosted LED bulb included

PRICE
€ 335 / £ 305 / DKK 2.495 / SEK 3.349 /
NOK 3.349 / USD 509 / CAD 659

ACCESSORIES

DOTS WOOD COAT HOOK by Lars Tornøe

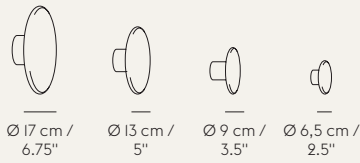

MATERIAL

Oak, ash or walnut. Colored versions in ash wood

AVAILABLE OPTIONS

All colors available in single packages. Oak, White, Black, Grey and Walnut also available in Set of 5 with 1 Ø17, 1 Ø13 and 3 Ø9 Dots

PRICE

Ø17 from € 29,50 / £ 27 / DKK 219 / SEK 295 / NOK 295 / USD 37 / CAD 48

Ø13 from € 27,50 / £ 25 / DKK 199 / SEK 269 / NOK 269 / USD 35 / CAD 45

Ø9 from € 22,50 / £ 21 / DKK 169 / SEK 229 / NOK 229 / USD 29 / CAD 37

Ø6,5 from € 18,50 / £ 17 / DKK 139 / SEK 189 / NOK 189 / USD 24 / CAD 30

Set of 5 from € 99,50 / £ 89 / DKK 795 / SEK 1.095 / NOK 1.095 / USD 149 / CAD 165

DOTS METAL COAT HOOK by Lars Tornøe

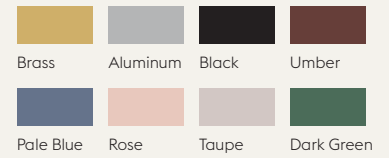

MATERIAL

Solid brass, anodized solid aluminum or stainless steel with PVD vacuum treated surface

AVAILABLE OPTIONS

All colors available in single packages and in a set of 5 with 1x Ø5, 1x Ø3,9 and 3x Ø2,7

PRICE

Ø5 € 25 / £ 23 / DKK 199 / SEK 269 / NOK 269 / USD 39 / CAD 49

Ø3,9 € 18,50 / £ 17 / DKK 149 / SEK 195 / NOK 200 / USD 29 / CAD 37

Ø2,7 € 12,50 / £ 12 / DKK 99 / SEK 135 / NOK 135 / USD 19 / CAD 25

Set of 5 € 69 / £ 65 / DKK 549 / SEK 695 / NOK 739 / USD 105 / CAD 135

DOTS CERAMIC COAT HOOK by Lars Tornøe

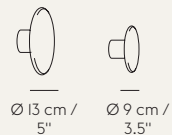

MATERIAL

Earthenware with reactive glaze

AVAILABLE OPTIONS

Both colors sold in single packages. Available in size Ø9 or Ø13

PRICE

Ø13 € 39,50 / £ 36 / DKK 295 / SEK 399 / NOK 399 / USD 50 / CAD 65

Ø9 € 35 / £ 32 / DKK 249 / SEK 335 / NOK 335 / USD 44 / CAD 59

FRAMED MIRROR by Anderssen & Voll

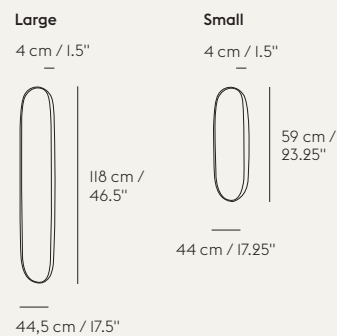

Frame/Mirror Glass

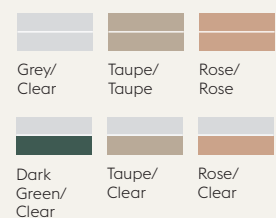

MATERIAL

Powder coated steel, mirror glass sheet

PRICE

Large € 549 / £ 495 / DKK 3.995 / SEK 5.395 / NOK 5.395 / USD 839 / CAD 1.095

Small € 249 / £ 225 / DKK 1.995 / SEK 2.695 / NOK 2.695 / USD 379 / CAD 405

ATTACH COAT HOOK by Dimitri Bähler

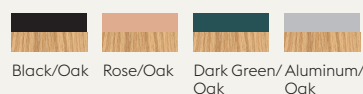
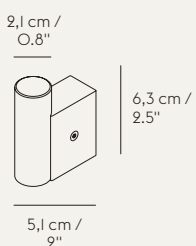

MATERIAL

Base in aluminum, hook in oak

AVAILABLE OPTIONS

Sold in set of two

PRICE

Set of 2 € 39 / £ 36 / DKK 299 / SEK 405 / NOK 405 / USD 49 / CAD 65

PLANK COAT RACK by Sam Hecht & Kim Colin

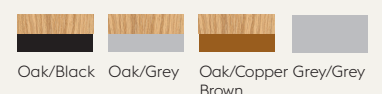
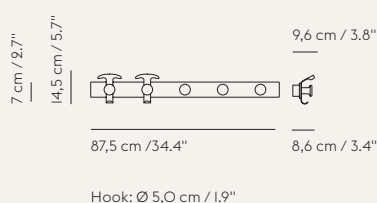

MATERIAL

Rack and dots in FSC®-certified oak that is either oiled or lacquered. Hooks in powder-coated steel.

PRICE

€ 195 / £ 175 / DKK 1.495 / SEK 2.049 / NOK 2.049 / USD 245 / CAD 319



RESTORE BASKET

by Mika Tolvanen



35 x 48 cm /
13.75" x 19"



MATERIAL
Polymer PET felt

PRICE
€ 79 / £ 75 / DKK 599 / SEK 795 / NOK 805 /
USD 119 / CAD 155

RESTORE TRAY

by Mika Tolvanen



31 x 40 cm /
12.25" x 15.75"



MATERIAL
Polymer PET felt

PRICE
€ 69 / £ 65 / DKK 499 / SEK 675 / NOK 675 /
USD 99 / CAD 135

Accessories

RESTORE ROUND BASKET

by Mika Tolvanen



Ø 51 cm /
20"



MATERIAL
Polymer PET felt

PRICE
€ 99 / £ 89 / DKK 749 / SEK 1.049 / NOK 1.049 /
USD 149 / CAD 195

STORY PINBOARD

by Big-Game

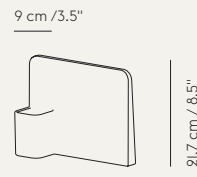

28,5 cm / 11.2"



MATERIAL
Cork

PRICE
€ 55 / £ 50 / DKK 399 / SEK 539 / NOK 539 /
USD 69 / CAD 89

82

ARRANGE DESKTOP SERIES

by Big-Game

Trays

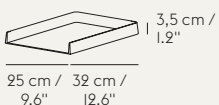

25 cm / 32 cm /
9.6" / 12.6"

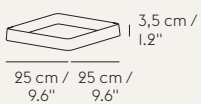

25 cm / 25 cm /
9.6" / 9.6"

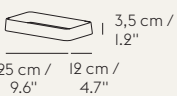

25 cm / 12 cm /
9.6" / 4.7"

Lids



12 cm / 24 cm /
4.7" / 9.4"

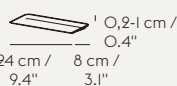

24 cm / 8 cm /
9.4" / 3.1"

Trays

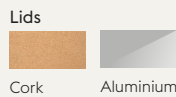
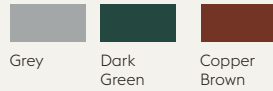

MATERIAL

Trays are made in Recycled PP. Lid in either cork or anodized aluminum.

PRICE

Configuration € 73,50 / £ 69 / DKK 549 /
SEK 739 / NOK 739 / USD 95 / CAD 119

Tray 32x25 € 26,20 / £ 24 / DKK 195 /
SEK 265 / NOK 265 / USD 33 / CAD 43

Tray 25x25 € 20 / £ 18 / DKK 149 / SEK 200 /
NOK 200 / USD 25 / CAD 33

Tray 12x25 € 17,50 / £ 16 / DKK 129 / SEK 175 /
NOK 175 / USD 22 / CAD 29

Lid € 12,80 / £ 12 / DKK 95 / SEK 129 /
NOK 129 / USD 16 / CAD 21

Prearranged configurations

Config. 1

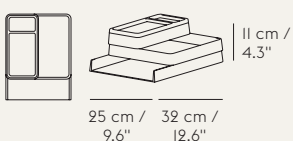

25 cm / 32 cm /
9.6" / 12.6"

Config. 2

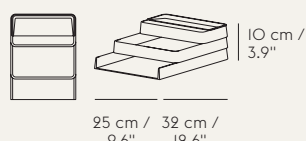

25 cm / 32 cm /
9.6" / 12.6"

FOLDED SHELVES

by Johan van Hengel

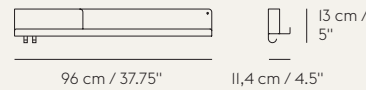

96 cm / 37.75" / 11,4 cm / 4.5"

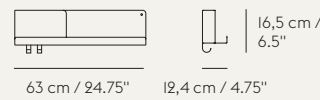

63 cm / 24.75" / 12,4 cm / 4.75"

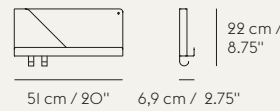

51 cm / 20" / 6,9 cm / 2.75"

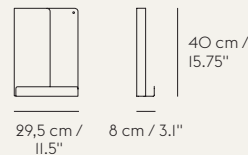

29,5 cm / 11.5" / 8 cm / 3.1"



MATERIAL

Acrylic powder coated steel

EXTRA

All shelves come with two black bolts and two black hooks

PRICE

96 x 13 € 165 / £ 149 / DKK 1.249 / SEK 1.695 /
NOK 1.695 / USD 249 / CAD 325

63 x 16,5 € 129 / £ 119 / DKK 995 / SEK 1.349 /
NOK 1.349 / USD 195 / CAD 249

51 x 22 € 99 / £ 89 / DKK 695 / SEK 935 /
NOK 835 / USD 149 / CAD 195

29,5 x 40 € 99 / £ 89 / DKK 695 / SEK 935 /
NOK 935 / USD 149 / CAD 195

COMPILE BOOKEND
by Cecilie Manz

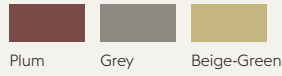
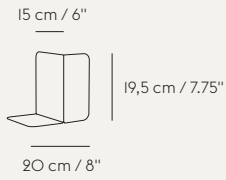

MATERIAL
Powder coated steel

PRICE
€ 35 / £ 32 / DKK 249 / SEK 335 / NOK 335 /
USD 44 / CAD 59

TUB JUG
by Atelier BL119

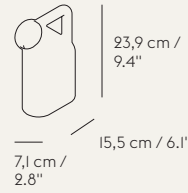

MATERIAL
Stoneware with glaze

PRICE
€ 79 / £ 75 / DKK 595 / SEK 799 / NOK 799 /
USD 99 / CAD 129

CORKY CARAFE & GLASSES
by Andreas Engesvik

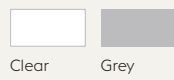
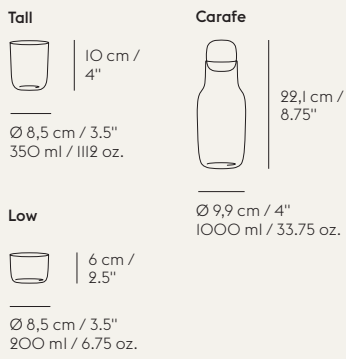

MATERIAL
Glass, cork

PRICE
Carafe € 49 / £ 45 / DKK 349 / SEK 449 /
NOK 469 / USD 65 / CAD 79

Glasses Low - Set of 4 € 39 / £ 35 / DKK 299 /
SEK 399 / NOK 405 / USD 49 / CAD 65

Glasses Tall - Set of 4 € 49 / £ 45 / DKK 369 /
SEK 495 / NOK 495 / USD 65 / CAD 79

PLATFORM TRAY
by Sam Hecht & Kim Colin

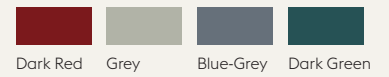
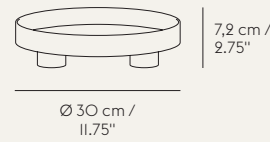

MATERIAL
Tray in ABS, insert in laminated oak veneer

PRICE
€ 59 / £ 55 / DKK 399 / SEK 549 / NOK 539 /
USD 75 / CAD 99

KINK VASE
by Earnest Studio

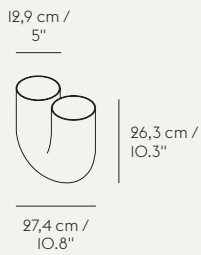

MATERIAL
Pigmented porcelain

PRICE
€ 179 / £ 165 / DKK 1.295 / SEK 1.749 /
NOK 1.749 / USD 269 / CAD 295

RIDGE VASE
by Studio Kaksikko

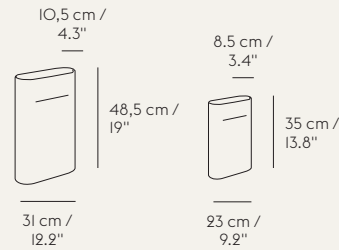

MATERIAL
Terracotta made of terracotta. Off-White
made of earthenware. Glazed inside, raw
outside

PRICE
H48,5 € 179 / £ 165 / DKK 1.295 / SEK 1.749 /
NOK 1.749 / USD 225 / CAD 295

H35 € 99 / £ 89 / DKK 749 / SEK 1.049 /
NOK 1.049 / USD 125 / CAD 165

ELEVATED VASE
by Thomas Bentzen

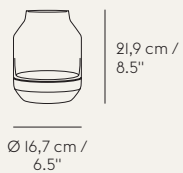

MATERIAL
Mouth blown glass, solid ash wood

PRICE
€ 99 / £ 89 / DKK 699 / SEK 899 / NOK 939 /
USD 129 / CAD 165

OPEN CANDELABRA

by Jens Fager

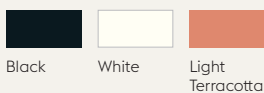
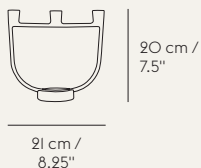

MATERIAL
Powder coated aluminum alloy

PRICE
€ 79 / £ 75 / DKK 595 / SEK 799 / NOK 799 /
USD 99 / CAD 129

GROOVE TRIVET

by Hallgeir Homstvedt

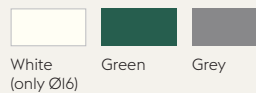
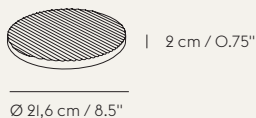

MATERIAL
Solid marble

PRICE
Ø21,6 € 59 / £ 55 / DKK 399 / SEK 539 /
NOK 495 / USD 75 / CAD 99
Ø16 € 39 / £ 36 / DKK 299 / SEK 399 /
NOK 405 / USD 49 / CAD 65

PEBBLE RUG

by Margrethe Odgaard

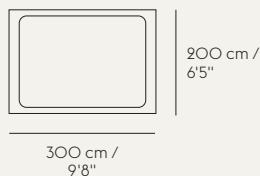

MATERIAL
60% New Zealand wool & 40% jute

PRICE
200 x 300 € 1.695 / £ 1.549 / DKK 12.495 /
SEK 16.995 / NOK 16.995 / USD 2,495 /
CAD 2,749

170 x 240 € 1.095 / £ 985 / DKK 7.995 /
SEK 10.995 / NOK 10.995 / USD 1,395 /
CAD 1,795

Please note that all sizes of the Pebble Rug
have a sizing toleration of + / - 2%, meaning
that the dimensions of the rug can differ
by a maximum of 2%

PLY RUG

by Margrethe Odgaard

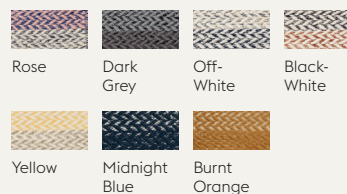
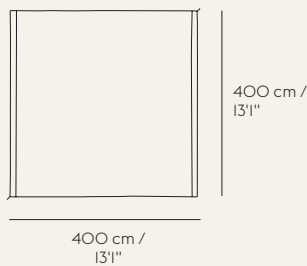

MATERIAL
100% New Zealand wool

PRICE
400 x 400 € 2.795 / £ 2.549 / DKK 20.995 /
SEK 28.495 / NOK 28.495 / USD 3,495 /
CAD 4,549

270 x 360 € 1.795 / £ 1.649 / DKK 12.995 /
SEK 17.495 / NOK 17.495 / USD 2,249 /
CAD 2,949

200 x 300 € 995 / £ 895 / DKK 7.695 /
SEK 10.495 / NOK 10.495 / USD 1,249 /
CAD 1,649

170 x 240 € 695 / £ 625 / DKK 4.995 /
SEK 6.449 / NOK 6.745 / USD 869 / CAD 1,149

80 x 200 € 299 / £ 269 / DKK 2.249 /
SEK 3.049 / NOK 3.049 / USD 375 /
CAD 485

85 x 140 € 229 / £ 209 / DKK 1.695 /
SEK 2.295 / NOK 2.295 / USD 285 / CAD 375

Please note that 400 x 400 and 270 x
360 are not available in Burnt Orange

Accessories

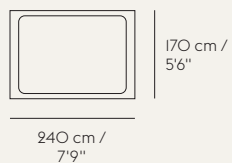

84

VARJO RUG

by Tina Ratzer

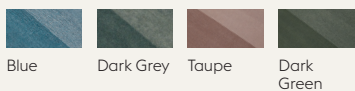
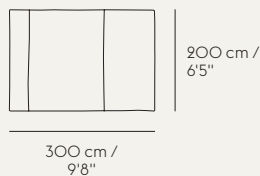

MATERIAL
100% New Zealand wool

PRICE
200 x 300 € 829 / £ 745 / DKK 6.295 /
SEK 8.495 / NOK 8.495 / USD 1,049 /
CAD 1,349

170 x 240 € 629 / £ 565 / DKK 4.695 /
SEK 6.349 / NOK 6.349 / USD 785 /
CAD 1,049

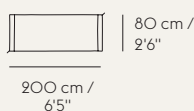
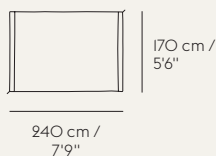
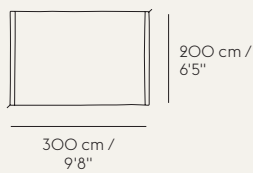
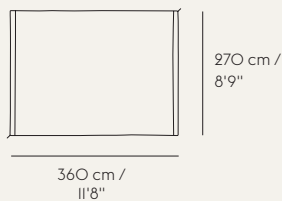
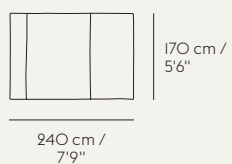

RHYTHM THROW
by Aiayu

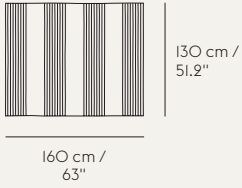

MATERIAL
100% baby llama wool

PRICE
€ 295 / £ 265 / DKK 1.995 / SEK 2.695 /
NOK 2.695 / USD 369 / CAD 479

AMPLE THROW
by Aiayu

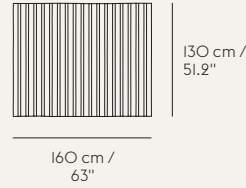

MATERIAL
100% baby llama wool

PRICE
€ 395 / £ 355 / DKK 2.995 / SEK 4.049 /
NOK 4.049 / USD 495 / CAD 645

SWAY THROW
by Tina Ratzer

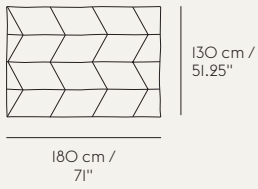

MATERIAL
100% fine merino wool

PRICE
€ 149 / £ 135 / DKK 995 / SEK 1.349 /
NOK 1.349 / USD 189 / CAD 245

LOOM THROW
by Simon Key Bertman

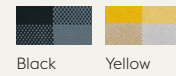
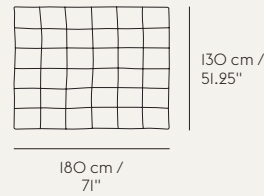

MATERIAL
100% cotton

PRICE
€ 99 / £ 89 / DKK 695 / SEK 895 / NOK 935 /
USD 139 / CAD 165

LAYER CUSHION
by Aiayu

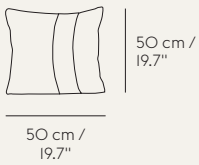

MATERIAL
Fabric: 100% baby llama wool
Inner Sham: 100% cotton
Filling: Mix of feather and polyfiber

PRICE
50 x 50 € 99 / £ 89 / DKK 749 / SEK 1.049 /
NOK 1.049 / USD 125 / CAD 165

40 x 60 € 99 / £ 89 / DKK 749 / SEK 1.049 /
NOK 1.049 / USD 125 / CAD 165

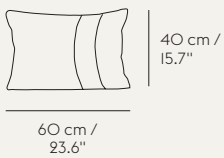

TWINE CUSHION
by Aiayu

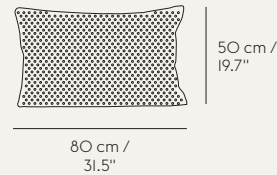

MATERIAL
Fabric: 100% baby llama wool
Inner Sham: 100% cotton
Filling: Mix of feather and polyfiber

PRICE
40 x 60 € 179 / £ 165 / DKK 1.295 / SEK 1.749 /
NOK 1.749 / USD 225 / CAD 295

50 x 80 € 229 / £ 209 / DKK 1.695 / SEK
2.295 / NOK 2.295 / USD 285 / CAD 375

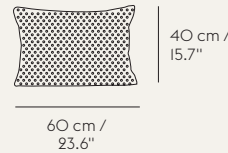

TILE CUSHION
by Anderssen & Voll

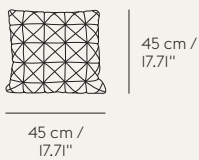

MATERIAL
Fabric: 100% wool woven at Gudbrandsdalens Uldvarefabrik in Norway for Muuto.
Filling: Mix of feather and polyester

PRICE
€ 119 / £ 109 / DKK 799 / SEK 1.095 /
NOK 1.095 / USD 169 / CAD 195

Please note that Tile Cushion is not
available for sale in North America

ACCENT CUSHION
by Margrethe Odgaard

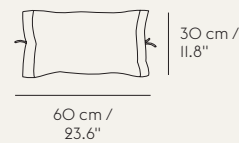

MATERIAL
Fabric: 100% cotton with silk print
Filling: Polyester

PRICE
€ 69 / £ 65 / DKK 495 / SEK 665 / NOK 665 /
USD 89 / CAD 115

A SUSTAINABLE PERSPECTIVE

We strive to create designs that are long-lasting in their expression and quality, allowing for them to be used for many years into the future. As part of this emphasis, continuous testing is at the heart of our design and development process to ensure high levels of quality. All Muuto furniture is produced in Europe and North America to underline this focus.

Being a design-centric company, aesthetic longevity serves as a guiding principle in our design process, meaning that we seek to create designs that have an individual character while being visually relevant for a long time, shying away from the influences of fast-moving trends.



ENVIRONMENTALLY-FRIENDLY DESIGNS

Labels & Certificates

We want to take responsibility for the planet that we inhabit and the impact of our operations hereon by creating designs with lessened impact on the environment.

We seek to verify our products to high environmental standards and use these as guiding elements in our product development. Muuto participates in Declare with an extensive selection of furniture being Living Building Challenge Compliant. Declare examines the origin and ingredient report of each product. Furthermore, a number of Muuto furniture designs are Global GreenTag Level C-certified.

Muuto is an FSC®-certified company. FSC stands for Forest Stewardship Council® and confirms that a forest is managed in an environmentally responsible manner to preserve the biodiversity in the given area.



95% of all textiles used in our upholstered products hold the EU Ecolabel, a label of environmental excellence awarded to products that meet high environmental standards throughout their lifecycle.

A large number of our furniture and accessories designs have the EAC Declaration of Conformity to Technical Regulations of the Eurasian Economic Union.

Materials

We seek to work with innovative materials that have an environmental upside to them, as seen in our Under The Bell Pendant Lamp and Restore Storage Series, both made using recycled plastic fibers, alongside our Fiber Chair Series, made in a unique, recyclable composite with up to 25% wood fibers, and the Arrange Desktop Series, made in 100% recycled plastic.

All Muuto furniture packaging is made from at least 65% recycled material while our retail shopping bags are made from at least 90% recycled material.



HIGH-QUALITY PRODUCTS

For high levels of strength and stability, we test our products to the most demanding of tests within the furniture industry, making for extensive strength and stability that will allow for our products to be used for many years into the future.

Adding to that, we have comprehensive requirements for our suppliers, covering both legislative requirements as well as contract market demands within chemicals, quality and safety.

HEALTHIER INDOOR CLIMATES

We want to ensure that our products contribute towards healthier indoor climates.

VOC & Water-Based Lacquer

At Muuto, we create furniture designs that are placed in spaces where they are used for many years into the future. When a furniture product is placed in a room, it will emit a certain degree of its matter, known as volatile organic compounds, or VOCs, over time. How much it emits depends on its unique composition of materials. The majority of Muuto furniture products are VOC-tested to ensure that they contribute to healthier indoor environments.

Our water-based lacquer is an environmentally-friendly substitute to traditional oil-based lacquers. It emits fewer chemicals than oil-based lacquers, making for better working conditions and reducing waste in the production phase.

Textiles

95% of all textiles in our upholstered products hold the Greenguard Gold-certificate, verifying that their chemical and particle emissions fall within acceptable indoor air quality thresholds.



RESPONSIBLE MANUFACTURING & SAFETY

We want to secure that our products are socially responsible, both in the way that they are produced alongside contributing to safe environments.

Manufacturing & Safety

All Muuto manufacturers have signed our Muuto Code Of Conduct, prompting them to adhere to the United Nations principles of human rights, anticorruption and non-use of child labor.

Beyond complying with standard regulations in main markets, we also fire-test our upholstered products for regions and countries with specific requirements.



Artworks by

Amanda Beta
 Andredottir & Bobek
 Anne Brandhøj
 Anne Lind Sort
 Anne Nowak
 Alessi
 Atelier Plateau
 Else-Rikke Brun
 Anders von Greffelsejrn
 Hanna Heino
 Jeba Arkitekter
 Jonas Sangberg
 Kaya Skytte
 Kristel Laurits
 Kristine Mandsberg
 Leise Dich Abrahamsen
 Lene Bodker
 Linda Weimann
 Lis Skulptur
 Lumiere Bricoleur
 Line Busch
 Malene Bach
 Maria Lenskjold
 Mathilde Duus
 Meyer-Lavigne
 Nanna Gabriella
 Peter Sentegl
 Sacre Coeur
 Stine Juul Studio
 Studio Thinkinghand
 The Ode To
 Tove Tengå

Availability

Please note that all variants are subject to stock availability and certification across regions. Please check availability with your local retailer.

Prices

Please find recommended retail prices on muuto.com

Downloads

Find more product information, product fact sheets, assembly instructions, lifestyle images, packshots and much more on our download site download.muuto.com

Join Us

Sign up to our newsletter or follow us on social media to stay in the loop on new product releases, case stories and events.

muuto.com/newsletter
[instagram.com/muutodesign](https://www.instagram.com/muutodesign)
[pinterest.com/muuto](https://www.pinterest.com/muuto)
[facebook.com/muuto](https://www.facebook.com/muuto)
twitter.com/muutodesign
[linkedin.com/company/muuto](https://www.linkedin.com/company/muuto)

Muuto Head Office
 Østergade 36-38
 DK-1100 Copenhagen,
 Denmark

For more information
 visit muuto.com

By the leading
contemporary designers:

MULTI COM.

Aiayu
Anderssen & Voll
Andreas Bergsaker
Andreas Engesvik
Atelier BLI19
Benjamin Hubert
Big-Game
Broberg & Ridderstråle
Cecilie Manz
Claesson Koivisto Rune
David Geckeler
Dimitri Bähler
Earnest Studio
Form Us With Love
Hallgeir Homstvedt
Harri Koskinen
Iskos-Berlin
Jens Fager
Johan van Hengel
Julien De Smedt
Lars Tornøe
Margrethe Odgaard
Mattias Ståhlbom
MSDS Studio
Mika Tolvanen
Normal Studio
Sam Hecht & Kim Colin
Simon Key Bertman
Staffan Holm
Studio Kaksikko
Søren Rose Studio
TAF Studio
Thomas Bentzen
Thomas Bernstrand
Tina Ratzer
Tom Chung
Whatswhat

Styling:
Pernille Vest

Photography:
Petra Bindel / Mikkel Tjelleesen

Printing:
Narayana Press

Subject to printer's errors